

# SCHÉMA ZAPOJENÍ

## EZF 50/8 B

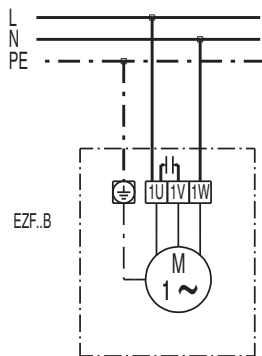
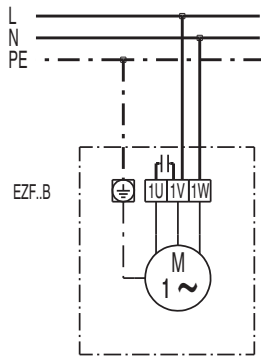

# SCHÉMA ZAPOJENÍ

## EZF 50/8 B

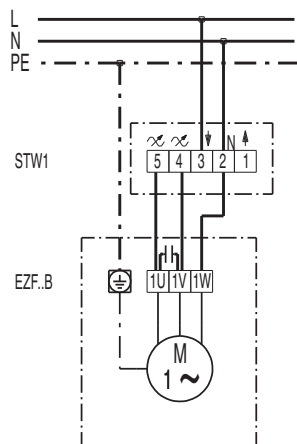
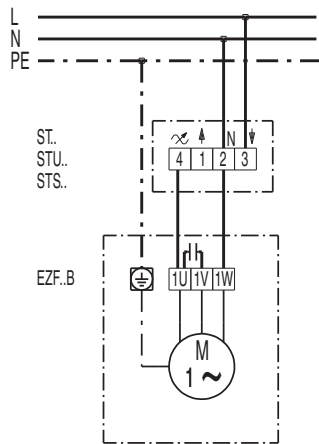

# SCHÉMA ZAPOJENÍ

## EZF 50/8 B

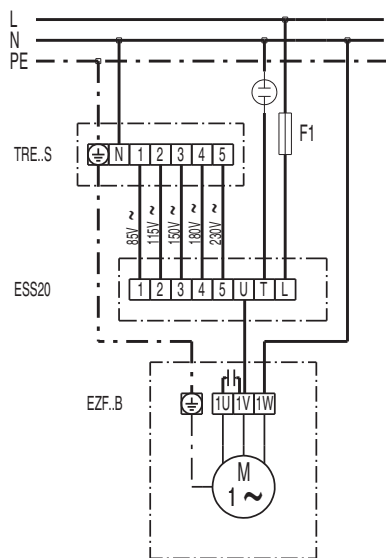
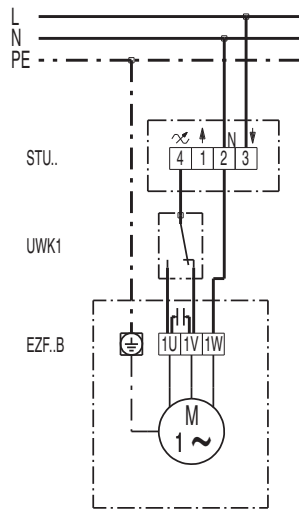

# EZF 50/8 B

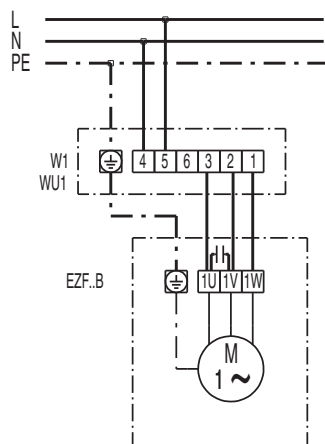
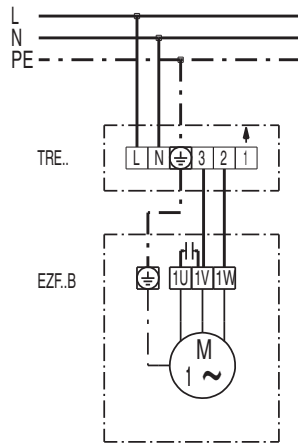

# SCHÉMA ZAPOJENÍ

## EZF 50/8 B

