

# ASI 22



## Short description

Intake socket for flow-optimised air intake, DN 225

Article number 0073.0434

## Technical data

Air direction	Ventilation and air extraction
Material	Sheet steel, coated
Colour	grey
Weight	0,6 kg
Weight including packaging	0,6 kg
Size	225
Width	280 mm
Height	200 mm
Depth	40 mm
Width with packaging	280 mm
Height with packaging	200 mm
Depth with packaging	40 mm
Packing unit	1 piece
Range	C
GTIN (EAN)	4012799734345

## Dimensioned drawing [mm]

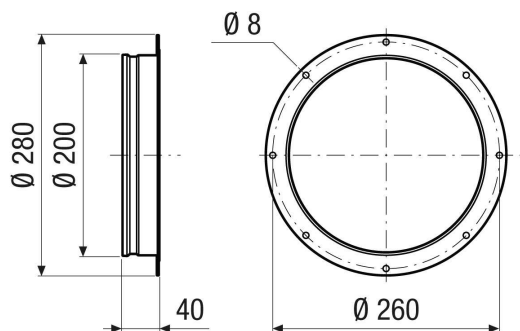

# ASI 22

