

# ASI 31



## Short description

Intake socket for flow-optimised air intake, DN 315

Article number 0073.0437

## Technical data

Air direction	Ventilation and air extraction
Material	Sheet steel, coated
Colour	grey
Weight	0,8 kg
Weight including packaging	0,8 kg
Size	315
Width	375 mm
Height	315 mm
Depth	55 mm
Width with packaging	375 mm
Height with packaging	315 mm
Depth with packaging	55 mm
Packing unit	1 piece
Range	C
GTIN (EAN)	4012799734376

## Dimensioned drawing [mm]

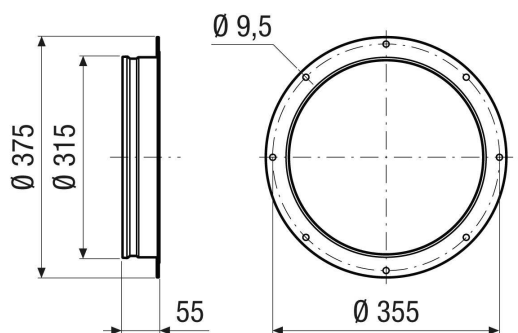

# ASI 31

