

DAR 112/6 4



Short description

Axial duct fan, DN 1120, three-phase AC, nominal power 4 kW

Application examples

Production facility, Workplace, Commercial premises, Industrial building

Article number 0073.0181

Technical data

Air flow volume	48.240 m ³ /h
Rotating speed	960 1/min
Impeller type	axial
Speed controllable	✓
Reversing capacity	–
Type of voltage	Three-phase AC
Rated voltage	400 V
Frequency	50 Hz
Nominal output	4.000 W
I _{nom}	8,85 A
Degree of protection	IP 55
Insulation class	F
Pole-changeable	–
Installation site	Duct
Installation position	Horizontal
Housing material	Sheet steel with epoxy coating
Impeller material	Polyamide
Colour	grey
Weight	162 kg
Weight including packaging	187 kg
Nominal size	1.120 mm
Width	1.250 mm
Height	750 mm
Depth	1.250 mm
Width with packaging	1.500 mm
Height with packaging	1.150 mm
Depth with packaging	1.490 mm
Airstream temperature at I _{Max}	-10 °C up to 50 °C
PTC DIN 44082	M 100

DAR 112/6 4

Packing unit	1 piece
Range	C
GTIN (EAN)	4012799731818

Technical data according to ErP in Best Efficiency Point (BEP)

Total efficiency η	46,4 %
Measurement category	C
Efficiency category	static
Efficiency level N	48,4
VSD necessary	No
Year of manufacture	see rating plate
Manufacturer's name / official registration number / manufacturer's place of establishment	Maico Elektroapparate-Fabrik GmbH / Freiburg registration court, HRB 601233 / Villingen-Schwenningen
Art. No.	0073.0181
P_{BEP} / Air volume $_{BEP}$ / $P_{fs, BEP}$	4,752 kW / 31.356 m ³ /h / 253 Pa
n_{BEP}	970 1/min
Specific ratio	≈ 1
Information about dismantling and disposal	see mounting instructions
Information about installation, operation and repairs	see mounting instructions
Objects used to measure efficiency which are not described by the measurement category	-
I_{BEP}	8,85 A
Sound power level $_{L_{WA7}}$	96 dB(A)

Sound power level in octave range

	63 Hz	125 Hz	250 Hz	500 Hz	1 kHz	2 kHz	4 kHz	8 kHz	Total
$L_{WA5, S5}$ (dB(A))	68	81	90	89	90	86	84	75	96

L_{WA5} = free inlet sound power level in dB.

DAR 112/6 4

Characteristic curve

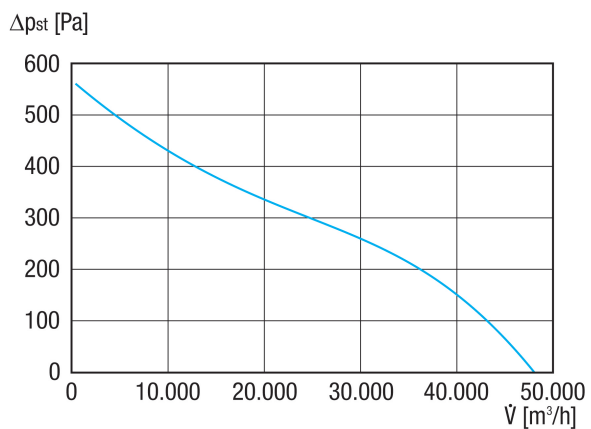

Dimensioned drawing [mm]

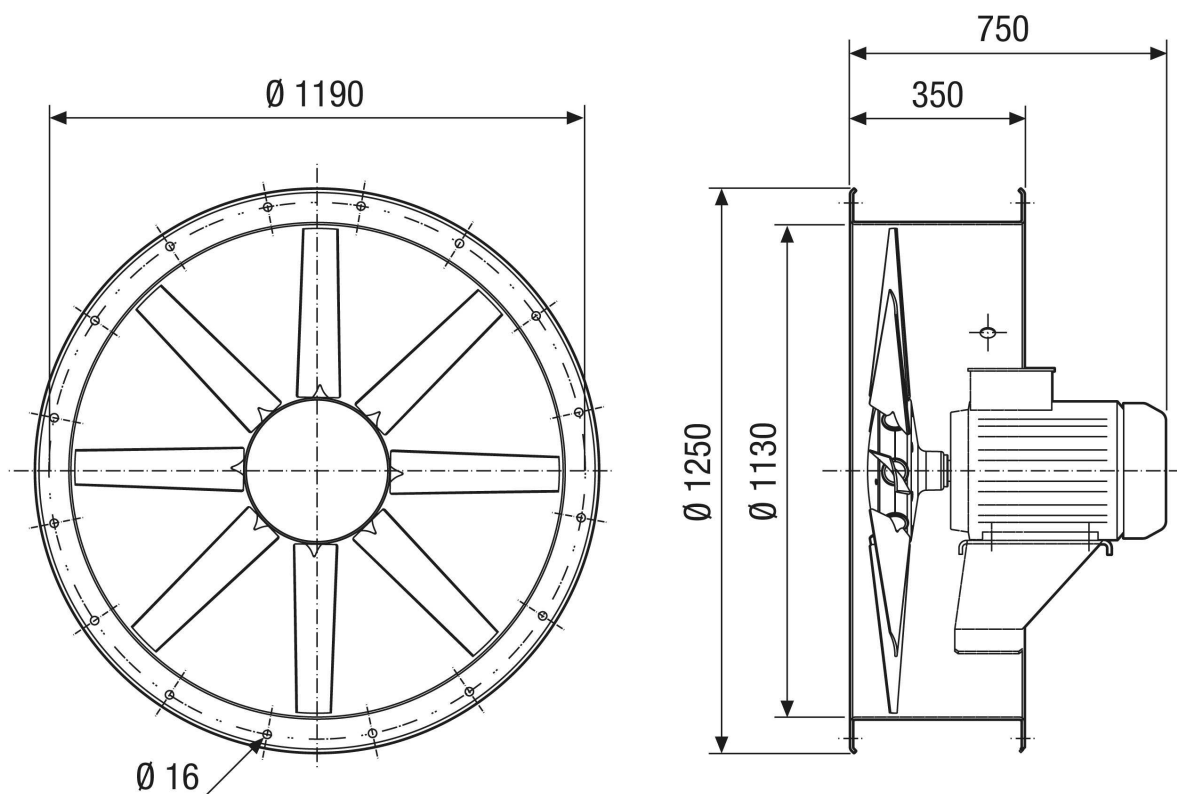

Quantity of holes: 20