

DAR 63/4 1,1



Short description

Axial duct fan, DN 630, three-phase AC, nominal power 1.1 kW

Application examples

Production facility, Workplace, Commercial premises, Industrial building

Article number 0073.0121

Technical data

Air flow volume	15.084 m ³ /h
Rotating speed	1.440 1/min
Impeller type	axial
Speed controllable	✓
Reversing capacity	–
Type of voltage	Three-phase AC
Rated voltage	400 V
Frequency	50 Hz
Nominal output	1.100 W
I _{nom}	2,5 A
Degree of protection	IP 55
Insulation class	F
Pole-changeable	–
Installation site	Duct
Installation position	Horizontal / Vertical
Housing material	Sheet steel with epoxy coating
Impeller material	Polyamide
Colour	grey
Weight	43 kg
Weight including packaging	48 kg
Nominal size	630 mm
Width	730 mm
Height	500 mm
Depth	730 mm
Width with packaging	830 mm
Height with packaging	600 mm
Depth with packaging	830 mm
Airstream temperature at I _{Max}	-10 °C up to 50 °C
PTC DIN 44082	M 100

DAR 63/4 1,1

Packing unit	1 piece
Range	C
GTIN (EAN)	4012799731214

Technical data according to ErP in Best Efficiency Point (BEP)

Total efficiency η	44,5 %
Measurement category	C
Efficiency category	static
Efficiency level N	50,5
VSD necessary	No
Year of manufacture	see rating plate
Manufacturer's name / official registration number / manufacturer's place of establishment	Maico Elektroapparate-Fabrik GmbH / Freiburg registration court, HRB 601233 / Villingen-Schwenningen
Art. No.	0073.0121
P_{BEP} / Air volume $_{BEP}$ / $P_{fs, BEP}$	1,093 kW / 9.425 m ³ /h / 185,7 Pa
n_{BEP}	1.420 1/min
Specific ratio	≈ 1
Information about dismantling and disposal	see mounting instructions
Information about installation, operation and repairs	see mounting instructions
Objects used to measure efficiency which are not described by the measurement category	-
I_{BEP}	2,5 A
Sound power level $_{L_{WA7}}$	82 dB(A)

Sound power level in octave range

	63 Hz	125 Hz	250 Hz	500 Hz	1 kHz	2 kHz	4 kHz	8 kHz	Total
$L_{WA5, S5}$ (dB(A))	57	64	69	74	77	76	75	69	82

L_{WA5} = free inlet sound power level in dB.

DAR 63/4 1,1

Characteristic curve

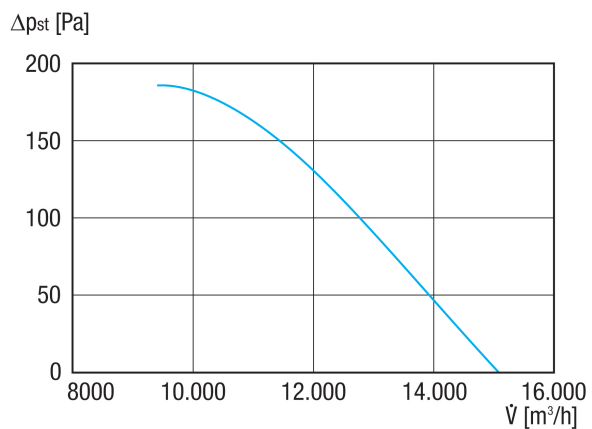

Dimensioned drawing [mm]

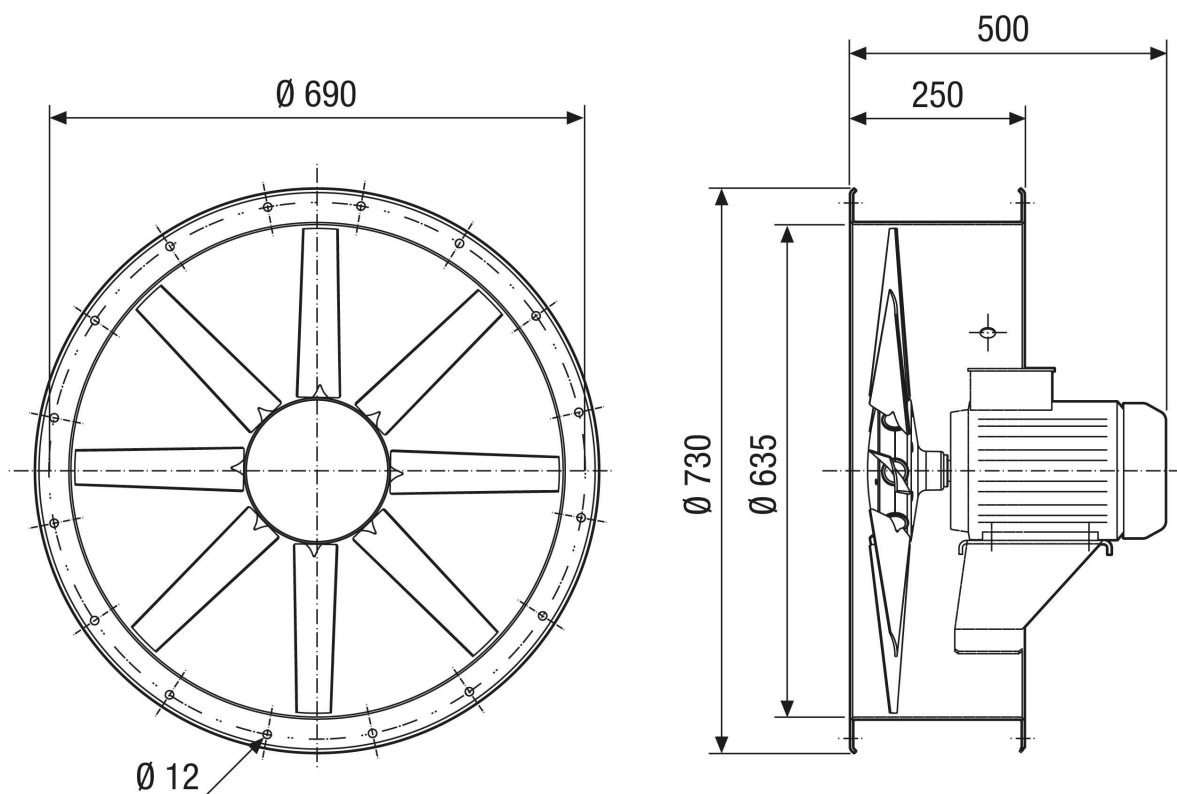

Quantity of holes: 12