

DZR 35/6 B



Short description

Axial duct fan, DN 350, three-phase AC

Application examples

Machine extraction unit, Showroom, Foreman's office, Workshop, Production site

Article number 0086.0026

Technical data

Air flow volume	1.800 m ³ /h
Rotating speed	930 1/min
Impeller type	axial
Speed controllable	✓
Reversing capacity	✓
Type of voltage	Three-phase AC
Rated voltage	400 V
Frequency	50 Hz
Nominal output	75 W
I _{nom}	0,17 A
I _{max}	0,17 A
Degree of protection	IP 55
Insulation class	B
Pole-changeable	–
Mains cable	7 x 1,5 mm ²
Installation position	horizontal / vertical
Material	Sheet steel, galvanised
Colour	Silver
Weight	9,6 kg
Weight including packaging	11,18 kg
Nominal size	350 mm
Width	420 mm
Height	474 mm
Depth	320 mm
Width with packaging	475 mm
Height with packaging	495 mm
Depth with packaging	355 mm
Airstream temperature at nominal current	-20 °C up to 60 °C
Airstream temperature at I _{Max}	-20 °C up to 60 °C

DZR 35/6 B

Packing unit	1 piece
Range	C
GTIN (EAN)	4012799860266

Sound power level in octave range

	63 Hz	125 Hz	250 Hz	500 Hz	1 kHz	2 kHz	4 kHz	8 kHz	Total
L_{WA2}, S1 (dB(A))	17	15	13	15	16	11	12	10	23
L_{WA2}, S2 (dB(A))	19	26	30	26	27	22	16	13	34
L_{WA2}, S3 (dB(A))	28	32	36	33	34	29	23	16	41
L_{WA2}, S4 (dB(A))	19	41	41	39	40	36	30	19	47
L_{WA2}, S5 (dB(A))	21	39	39	47	43	40	35	22	50
L_{WA5}, S1 (dB(A))	13	23	26	20	18	14	8	9	29
L_{WA5}, S2 (dB(A))	25	30	46	35	36	34	27	25	47
L_{WA5}, S3 (dB(A))	23	41	58	42	44	43	33	21	54
L_{WA5}, S4 (dB(A))	23	39	54	47	48	49	40	26	57
L_{WA5}, S5 (dB(A))	25	41	54	56	52	53	44	31	60
L_{WA6}, S1 (dB(A))	17	21	23	27	24	18	9	8	31
L_{WA6}, S2 (dB(A))	28	32	37	42	41	38	25	13	46
L_{WA6}, S3 (dB(A))	31	41	47	49	49	48	37	22	55
L_{WA6}, S4 (dB(A))	31	46	53	55	56	56	55	52	63
L_{WA6}, S5 (dB(A))	34	48	54	61	62	62	63	61	69

L_{WA2}= housing sound power level in dB.

L_{WA5}= free inlet sound power level in dB.

L_{WA6}= free outlet sound power level in dB.

DZR 35/6 B

Characteristic curve

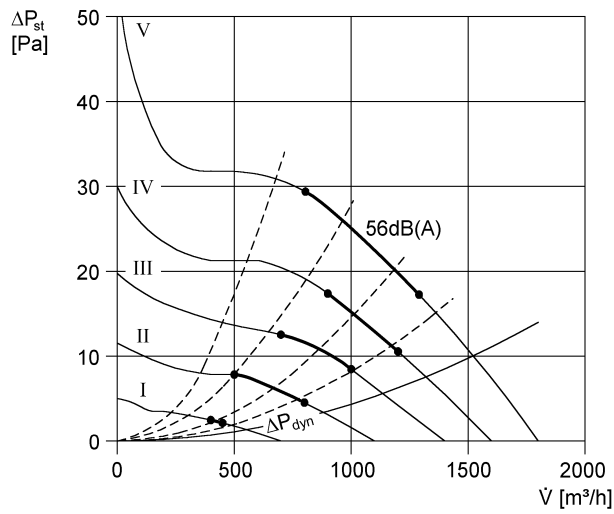

Dimensioned drawing [mm]

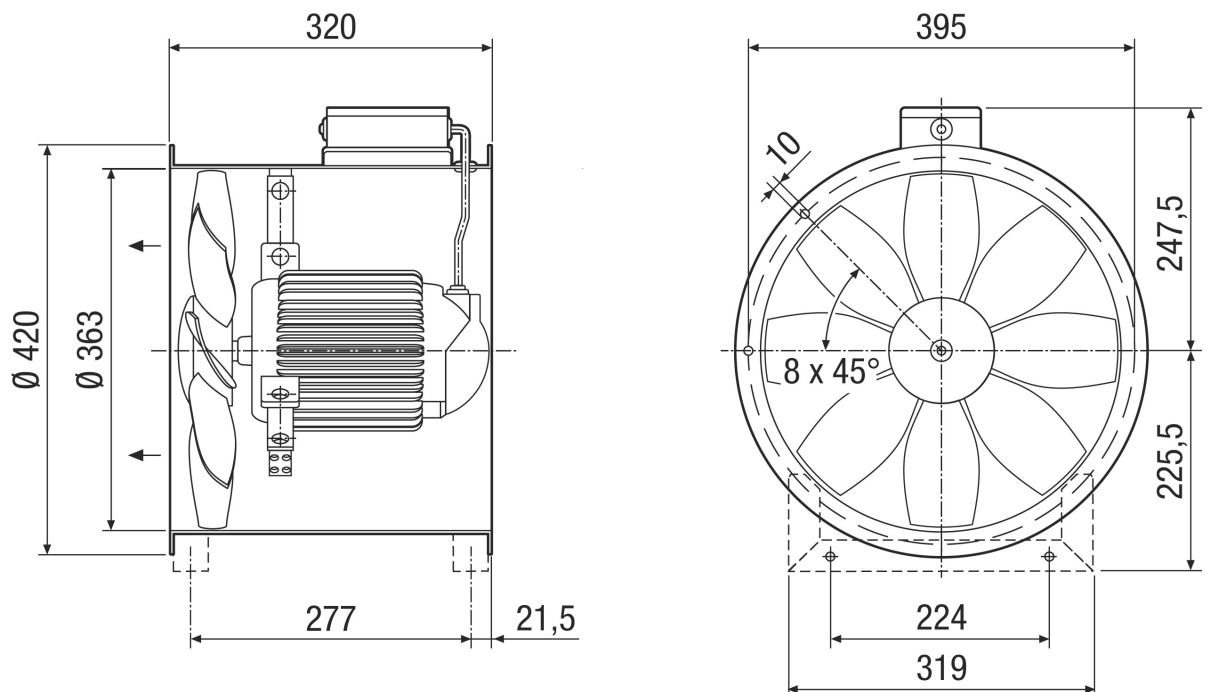

Number of flange holes: 8