

ELI 80

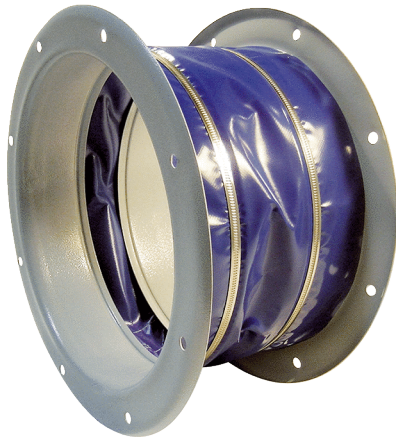

Short description

Flexible coupling for sound- and vibration-damped installation, DN 800

Article number 0073.0220

Technical data

Installation site	Fans
Material	Sheet steel, epoxy coated
Colour	grey
Weight	21 kg
Weight including packaging	21 kg
Nominal size	800 mm
Width	910 mm
Height	808 mm
Depth	203 mm
Width with packaging	910 mm
Height with packaging	808 mm
Depth with packaging	203 mm
Packing unit	1 piece
Range	C
GTIN (EAN)	4012799732204

Dimensioned drawing [mm]

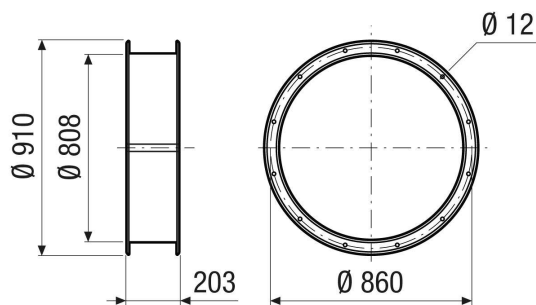

ELI 80

