

ELI v 31

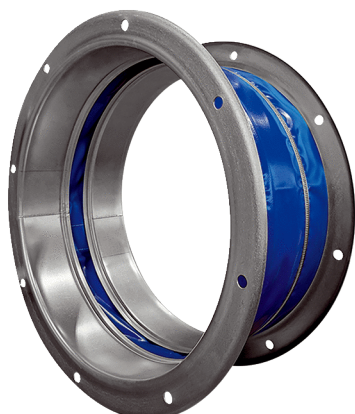

Short description

Flexible coupling for sound- and vibration-damped mounting, galvanised, DN 315

Article number 0073.0696

Technical data

Installation site	Fans
Material	Sheet steel, galvanised
Colour	Silver
Weight	5 kg
Weight including packaging	5 kg
Nominal size	315 mm
Width	396 mm
Height	203 mm
Depth	395 mm
Width with packaging	396 mm
Height with packaging	203 mm
Depth with packaging	395 mm
Packing unit	1 piece
Range	C
GTIN (EAN)	4012799736967

Dimensioned drawing [mm]

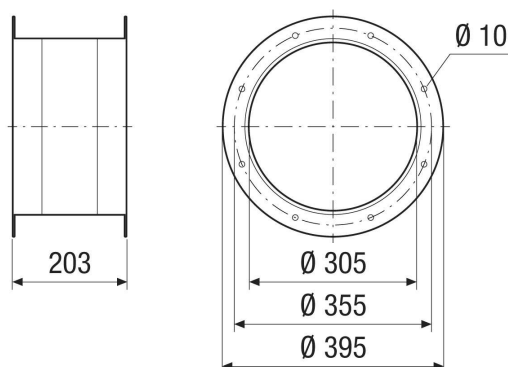

ELI v 31

