

ELI v 35



Short description

Flexible coupling for sound- and vibration-damped mounting, galvanised, DN 350

Article number 0073.0697

Technical data

Installation site	Fans
Material	Sheet steel, galvanised
Colour	Silver
Weight	6 kg
Weight including packaging	6 kg
Nominal size	350 mm
Width	446 mm
Height	203 mm
Depth	446 mm
Width with packaging	446 mm
Height with packaging	203 mm
Depth with packaging	446 mm
Packing unit	1 piece
Range	C
GTIN (EAN)	4012799736974

Dimensioned drawing [mm]

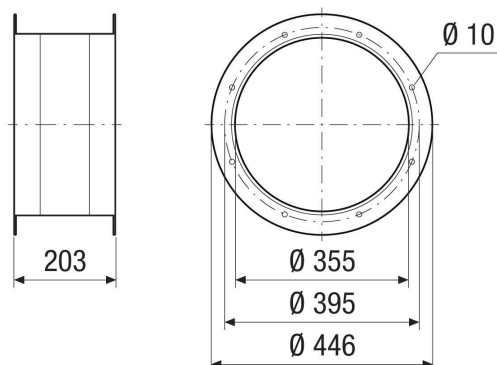

ELI v 35

