

ELI v 45

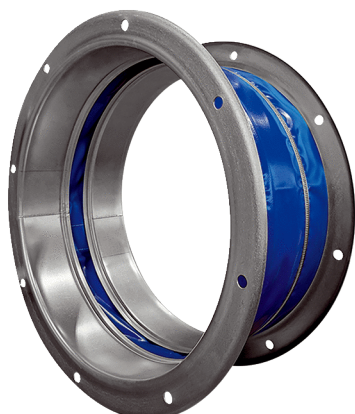

Short description

Flexible coupling for sound- and vibration-damped mounting, galvanised, DN 450

Article number 0073.0698

Technical data

Installation site	Fans
Material	Sheet steel, galvanised
Colour	Silver
Weight	8 kg
Weight including packaging	8 kg
Nominal size	450 mm
Width	546 mm
Height	203 mm
Depth	546 mm
Width with packaging	546 mm
Height with packaging	203 mm
Depth with packaging	546 mm
Packing unit	1 piece
Range	C
GTIN (EAN)	4012799736981

Dimensioned drawing [mm]

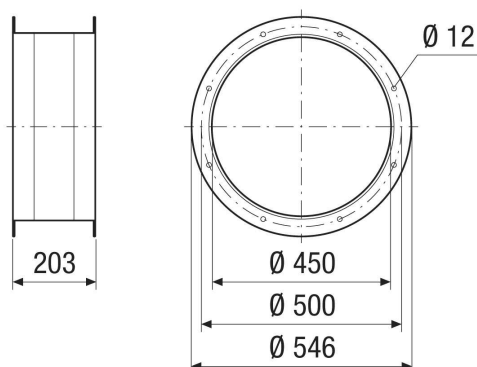

ELI v 45

