

# ELM 12 Ex



## Short description

Flexible cuff with 2 tensioning straps, DN 125, suitable for use in areas subject to explosion hazards

Article number 0092.0262

## Technical data

Material	Synthetic material, antistatic
Colour	Black
Weight	0,08 kg
Weight including packaging	0,1 kg
Suitable for nominal size	125 mm
Width	125 mm
Height	125 mm
Depth	110 mm
Width with packaging	200 mm
Height with packaging	30 mm
Depth with packaging	110 mm
Ambient temperature	50 °C
Ex version	antistatic
Packing unit	1 piece
Range	G
GTIN (EAN)	4012799922629

# ELM 12 Ex

Dimensioned drawing [mm]

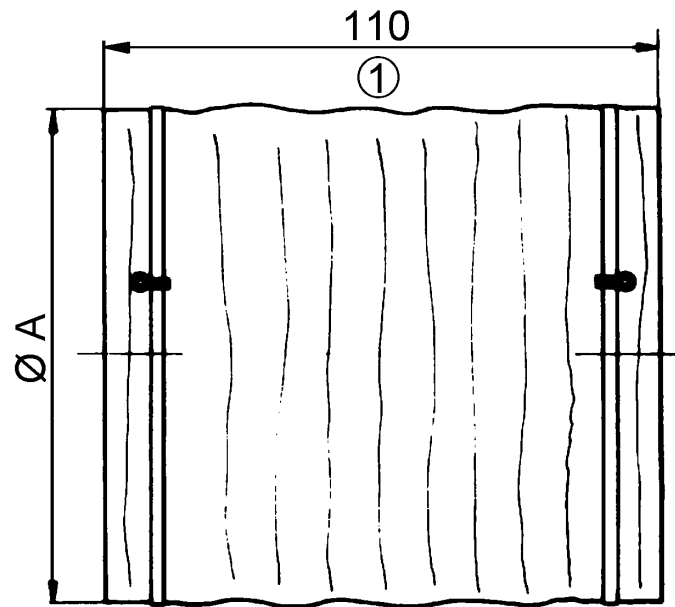

A

125

① Extended length