

ESR 12-3 EC



Short description

Sound-insulated ventilation box with EC motor and swivelling fan, DN 125, single-phase AC

Application examples

Commercial premises, Showroom, Office, Foreman's office, Changing room

Article number 0080.1000

Technical data

Air flow volume	490 m³/h
Rotating speed	4.010 1/min
Impeller type	radial
Speed controllable	✓
Rated voltage	230 V
Frequency	50 Hz/60 Hz
Nominal output	121 W
I _{max}	1 A
Degree of protection	IP 54
Insulation class	F
Installation site	Wall / ceiling
Installation position	vertical / horizontal
Material	Sheet steel, galvanised
Colour	Silver
Weight	12,23 kg
Weight including packaging	13,63 kg
Swivelling fan	✓
Nominal size	125 mm
Width	386 mm
Height	232 mm
Depth	485 mm
Width with packaging	395 mm
Height with packaging	275 mm
Depth with packaging	565 mm
Airstream temperature at I _{Max}	50 °C
Ambient temperature	-30 °C up to 50 °C
Packing unit	1 piece
Range	E
GTIN (EAN)	4012799981039

ESR 12-3 EC

Sound power level in octave range

	63 Hz	125 Hz	250 Hz	500 Hz	1 kHz	2 kHz	4 kHz	8 kHz	Total
L_{WA2}, S1 (dB(A))	26	33	30	31	17	7	6	7	36
L_{WA2}, S2 (dB(A))	36	40	48	43	30	23	13	26	50
L_{WA2}, S3 (dB(A))	42	47	53	51	39	31	23	20	56
L_{WA2}, S4 (dB(A))	45	52	52	60	45	36	30	24	61
L_{WA2}, S5 (dB(A))	48	55	54	65	49	40	35	29	66
L_{WA5}, S1 (dB(A))	24	32	28	27	23	16	6	5	35
L_{WA5}, S2 (dB(A))	36	39	45	40	34	32	30	39	48
L_{WA5}, S3 (dB(A))	42	47	54	50	43	41	40	31	57
L_{WA5}, S4 (dB(A))	43	53	57	58	50	48	46	39	62
L_{WA5}, S5 (dB(A))	48	55	59	60	54	51	50	43	64
L_{WA6}, S1 (dB(A))	35	42	39	43	43	40	26	13	49
L_{WA6}, S2 (dB(A))	31	46	56	55	56	53	47	32	61
L_{WA6}, S3 (dB(A))	39	53	66	64	65	63	56	47	71
L_{WA6}, S4 (dB(A))	44	58	65	73	72	70	63	55	77
L_{WA6}, S5 (dB(A))	46	60	67	76	75	73	67	59	66

L_{WA2}= housing sound power level in dB.

L_{WA5}= free inlet sound power level in dB.

L_{WA6}= free outlet sound power level in dB.

ESR 12-3 EC

Characteristic curve

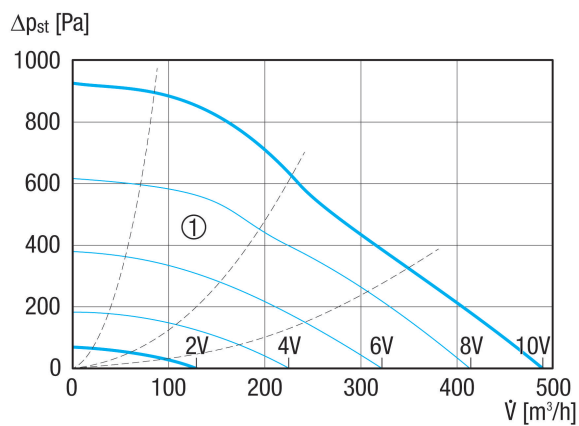

① Auxiliary characteristics curves for control voltage 2 - 10 V

ESR 12-3 EC

Dimensioned drawing [mm]

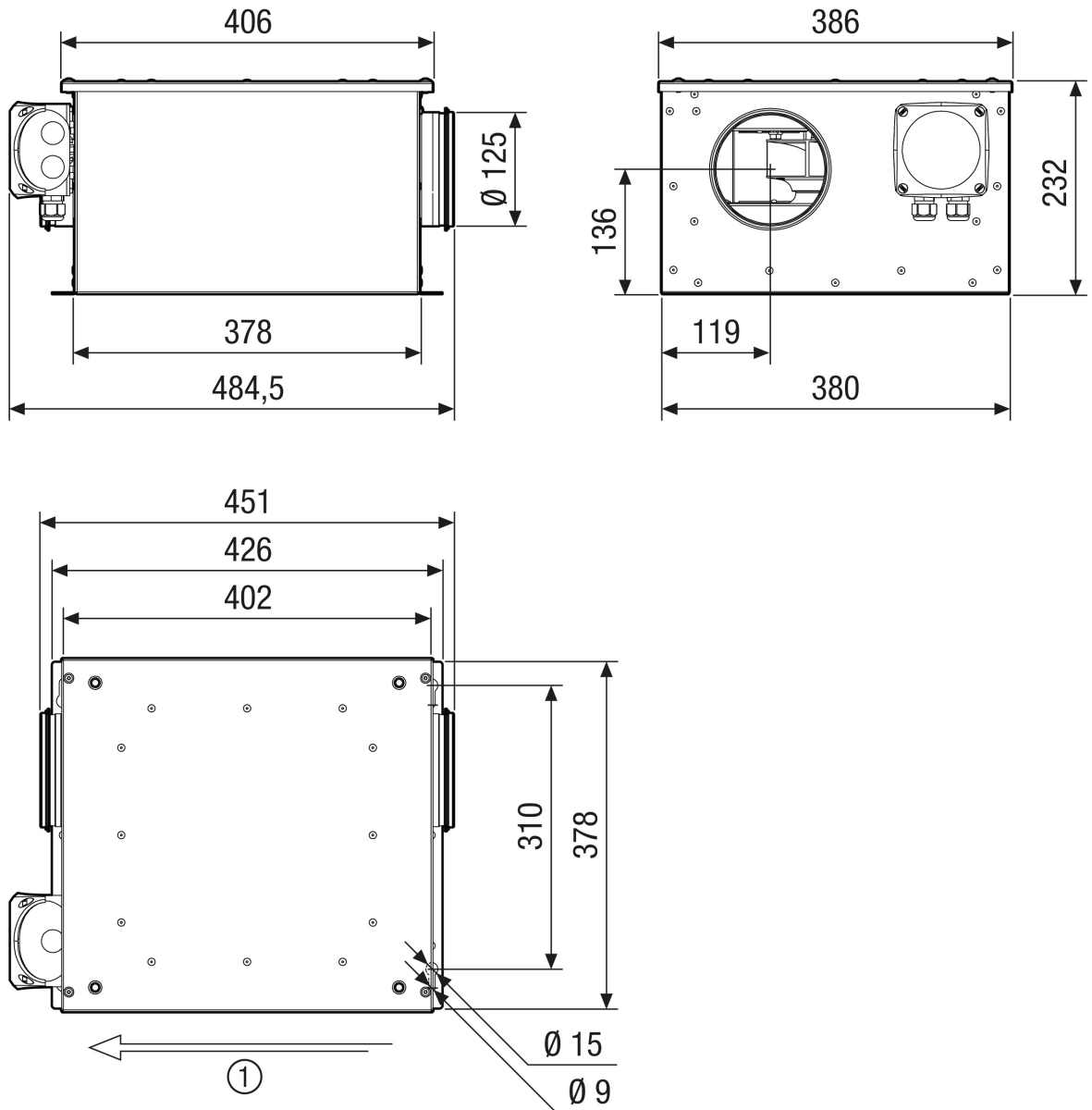

① Air direction