

GRK R 40/4 D



Short description

Centrifugal blower made of plastic with round exhaust opening, size 400, three-phase AC, 4-pin

Application examples

Industrial applications

Article number 0073.0524

Technical data

Air flow volume	4.600 m ³ /h
Rotating speed	1.440 1/min
Impeller type	radial
Speed controllable	✓
Reversing capacity	–
Type of voltage	Three-phase AC
Rated voltage	400 V
Frequency	50 Hz
Nominal output	550 W
I _{nom}	1,6 A
Degree of protection	IP 55
Insulation class	F
Pole-changeable	–
Installation site	Duct connection
Installation position	Horizontal
Housing material	Plastic, polyethylene
Impeller material	Plastic, polyethylene
Colour	Light grey
Weight	47 kg
Weight including packaging	74 kg
Size	400
Width	530 mm
Height	780 mm
Depth	675 mm
Width with packaging	1.200 mm
Height with packaging	800 mm
Depth with packaging	940 mm
Airstream temperature at I _{Max}	-15 °C up to 70 °C
PTC DIN 44082	M 100

GRK R 40/4 D

Packing unit	1 piece
Range	C
GTIN (EAN)	4012799735243

Sound power level in octave range

	63 Hz	125 Hz	250 Hz	500 Hz	1 kHz	2 kHz	4 kHz	8 kHz	Total
L_{WA5, S5} (dB(A))	55,3	67,4	75,9	76,3	78,5	74,7	66,5	56,4	83

L_{WA5}= free inlet sound power level in dB.

Characteristic curve

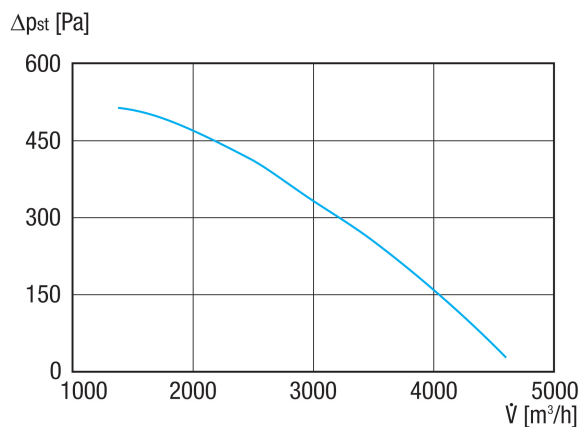

GRK R 40/4 D

Dimensioned drawing [mm]

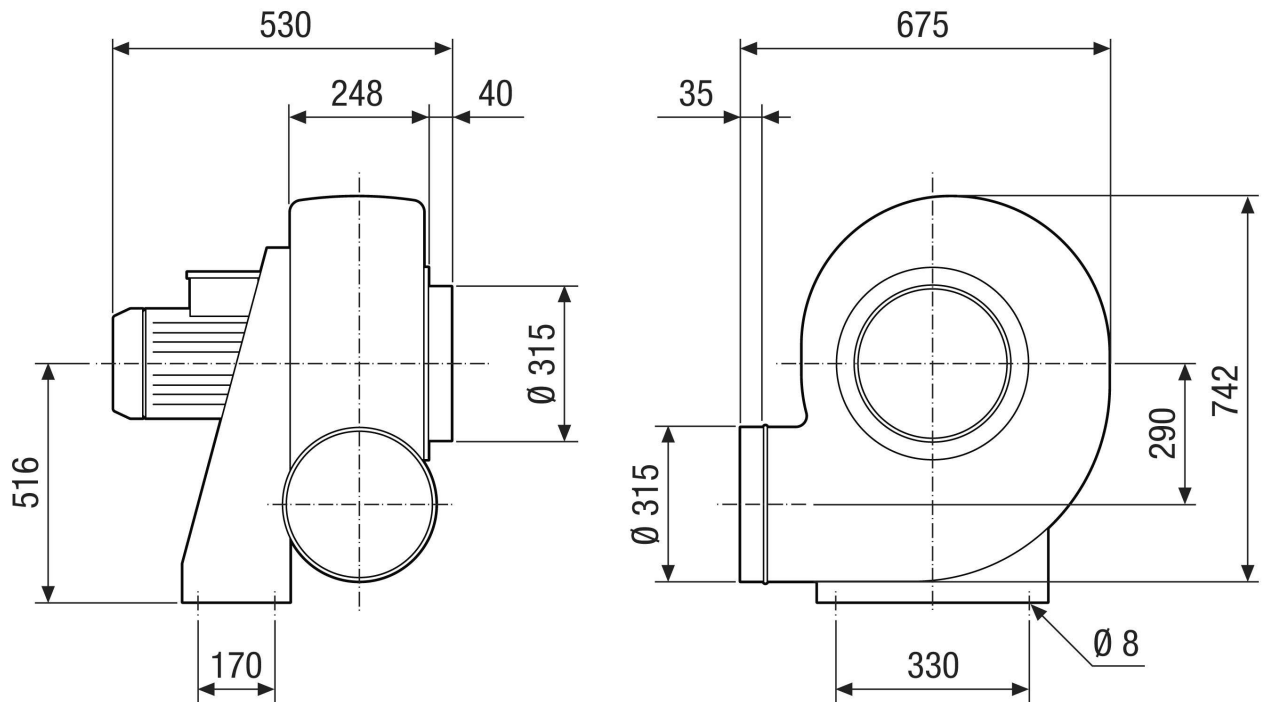

GRK R 40/4 D

Dimensioned drawing Housing orientation [mm]

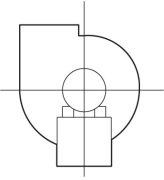
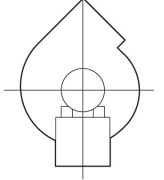
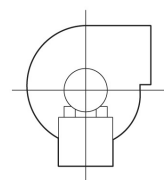
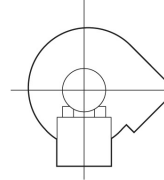
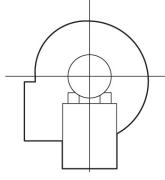
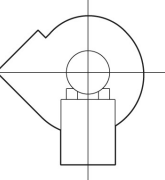
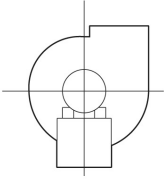
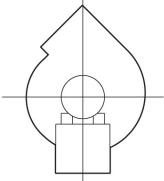
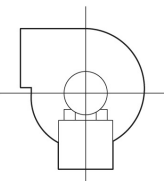
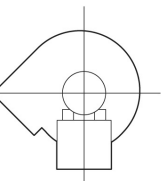
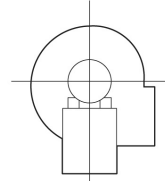
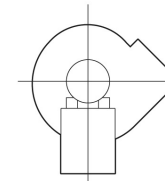
①						
	0°	45°	90°	135°	270°	315°
②						

① RD Right-hand version

② LG Left-hand version

The GRK 12/2 E and GRK 12/4 D variants are not available in right-hand version RD!

The standard orientation is always LG 270°