

GS 30



Short description

Counter socket for fitting DN 300 flexible cuffs on ventilation ducts

Article number 0055.0170

Technical data

Material	Sheet steel, galvanised
Weight	0,69 kg
Weight including packaging	0,7 kg
Suitable for nominal size cuffs	300 mm
Width	380 mm
Height	380 mm
Depth	50 mm
Width with packaging	380 mm
Height with packaging	380 mm
Depth with packaging	50 mm
Packing unit	1 piece
Range	C
GTIN (EAN)	4012799551706

Dimensioned drawing [mm]

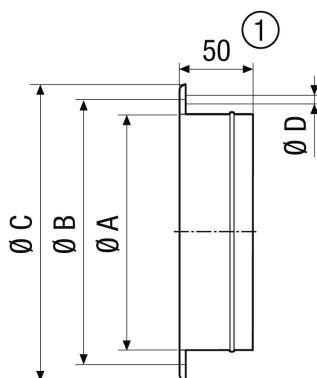

A	B	C	D
313	356	380	10

① GS 56: 55 mm