

# RSK 180



## Short description

Backflow preventer for folded spiral-seams ducts, DN 180

Article number 0092.0430

## Technical data

Type of installation	Recessed-mounted
Ambient temperature	60 °C
Packing unit	1 piece
Range	K
GTIN (EAN)	4012799924302

## Dimensioned drawing [mm]

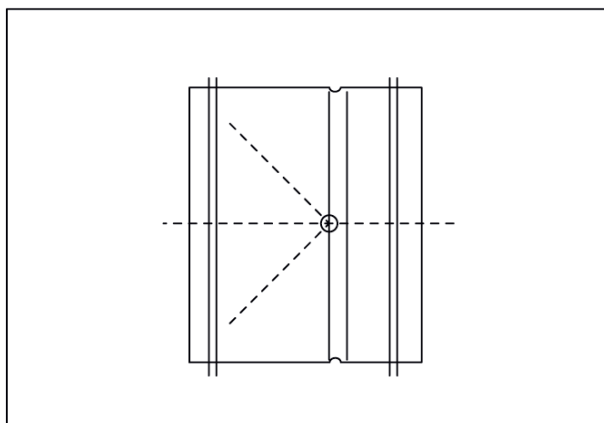

DN  
180