

SGCI v 63



Short description

Contact protection grille for free inlet in conical design, galvanised, DN 630

Article number 0073.0671

Technical data

Installation site	Fans
Material	Steel, galvanised
Colour	Silver
Weight	4,4 kg
Weight including packaging	4,4 kg
Nominal size	630 mm
Width	165 mm
Height	632 mm
Depth	165 mm
Width with packaging	165 mm
Height with packaging	632 mm
Depth with packaging	165 mm
Packing unit	1 piece
Range	C
GTIN (EAN)	4012799736714

Dimensioned drawing [mm]

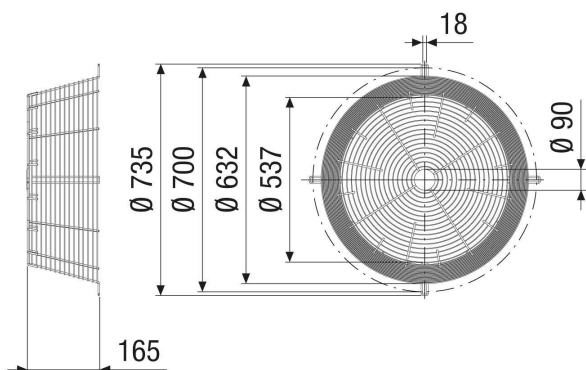

SGCI v 63

