

SGCI v 71



Short description

Contact protection grille for free inlet in conical design, galvanised, DN 710

Article number 0073.0672

Technical data

Installation site	Fans
Material	Steel, galvanised
Colour	Silver
Weight	4,95 kg
Weight including packaging	4,95 kg
Nominal size	710 mm
Width	165 mm
Height	713 mm
Depth	165 mm
Width with packaging	165 mm
Height with packaging	713 mm
Depth with packaging	165 mm
Packing unit	1 piece
Range	C
GTIN (EAN)	4012799736721

Dimensioned drawing [mm]

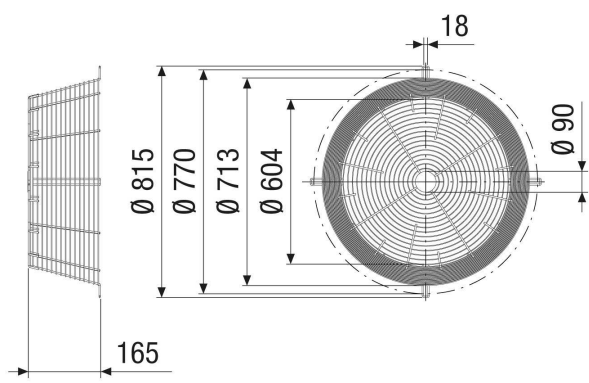

SGCI v 71

