

SGCI v 80



Short description

Contact protection grille for free inlet in conical design, galvanised, DN 800

Article number 0073.0673

Technical data

Installation site	Fans
Material	Steel, galvanised
Colour	Silver
Weight	6,75 kg
Weight including packaging	6,75 kg
Nominal size	800 mm
Width	162 mm
Height	798 mm
Depth	162 mm
Width with packaging	162 mm
Height with packaging	798 mm
Depth with packaging	162 mm
Packing unit	1 piece
Range	C
GTIN (EAN)	4012799736738

Dimensioned drawing [mm]

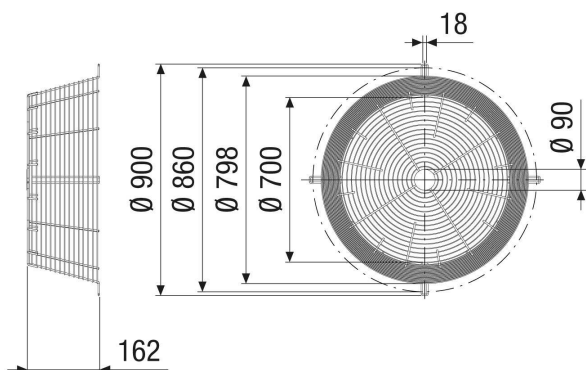

SGCI v 80

