

USSN80/150/80

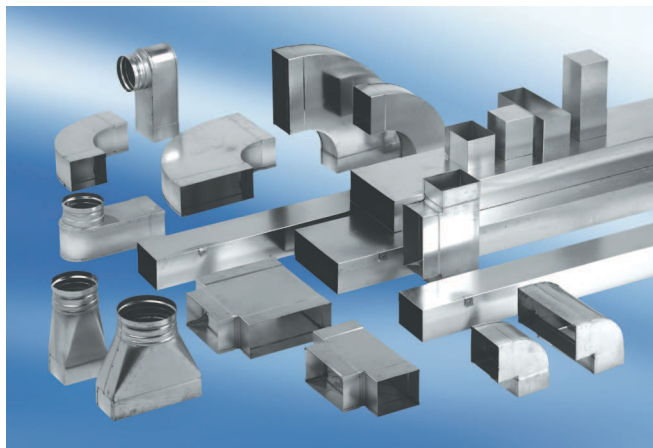

Short description

Transition piece: square, collar size, round symmetrical, nipple size. Surface: Sendzimir galvanised.

Article number 0055.0684

Technical data

Material	Sheet steel, Sendzimir galvanised
Weight including packaging	0 kg
Width with packaging	0 mm
Height with packaging	0 mm
Depth with packaging	0 mm
Packing unit	1 piece
Range	K
GTIN (EAN)	4012799556848

Dimensioned drawing [mm]

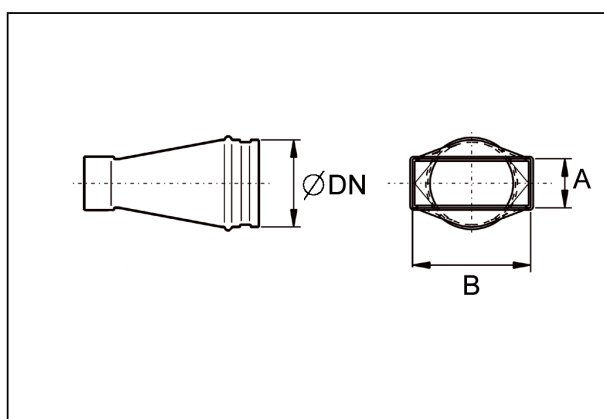

DN	A	B
80	80	150