

# geniovent.x 600 F R-G-SO-K



## Short description

Decentralised RLT air handling unit with very good heat recovery. With cross-counterflow heat exchanger and pre-heating register, outside air and outgoing air connections on right, air outlet at top, CO2 sensor integrated in unit. With app for mobile unit control system

Article number 0041.0242

## Technical data

Air flow volume	150 m³/h / 560 m³/h
SFP value	0,21 W/(m³/h)
Type of voltage	Alternating current
Rated voltage	230 V
Frequency	50 Hz
Nominal output	83 W
Stand-by power consumption	< 1 W
I <sub>max</sub>	14 A
Degree of protection	IP 40
Installation site	Inside
Material	Sheet steel, galvanised
Housing material	Sheet steel, galvanised
Heat exchanger material	Synthetic material
Inner coating material	Melamine resin foam with fleece
Colour	Pure white, similar to RAL 9010
Weight	200 kg
Weight including packaging	235 kg
Filter class	ISO ePM1 50-65% (F7) / ISO ePM10 60% (M5)
Connection diameter	250 mm
Connection diameter of condensation drain	7 mm (inside), 10 mm (outside)
Width	2.100 mm
Height	482 mm
Depth	800 mm
Width with packaging	2.250 mm
Height with packaging	950 mm
Depth with packaging	950 mm
Degree of heat provision	91 %
Heat exchanger construction type	Counter current
Bypass	Yes

# geniovent.x 600 F R-G-SO-K

Frost protection	integrated 1.5 kW
Supplementary heating	optional
Enthalpy heat exchanger	No
Antifreeze circuit	Yes
Filter monitoring	with time control
CO <sub>2</sub> regulation (optional)	integrated
Smoke gas switch	optional
Air quality control (optional)	VOC sensor for geniovent.x
Outside air shutters, automatic closing	integrated
Presence sensor	PIR motion sensor, optional
KNX connection (optional)	K-SM
MODBUS interface	integrated
BACnet interface	integrated
Ethernet interface	integrated
Control unit included in scope of delivery.	RB-ZF4
Control unit (optional)	RLS T1 SYS
EnOcean wireless integration (optional)	E-SM
Sound pressure level	35 dB(A) (at 0.7 * Vmax and 20 Pa pressure loss each OSA and OGA, with a room attenuation of approx. 11 dB)
Packing unit	1 piece
Range	X
GTIN (EAN)	4012799412427

## Characteristic curve

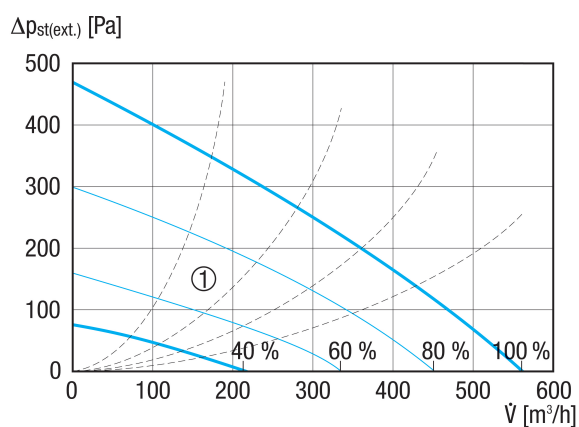

① Configuration range

# geniovent.x 600 F R-G-SO-K

## Dimensioned drawing [mm]

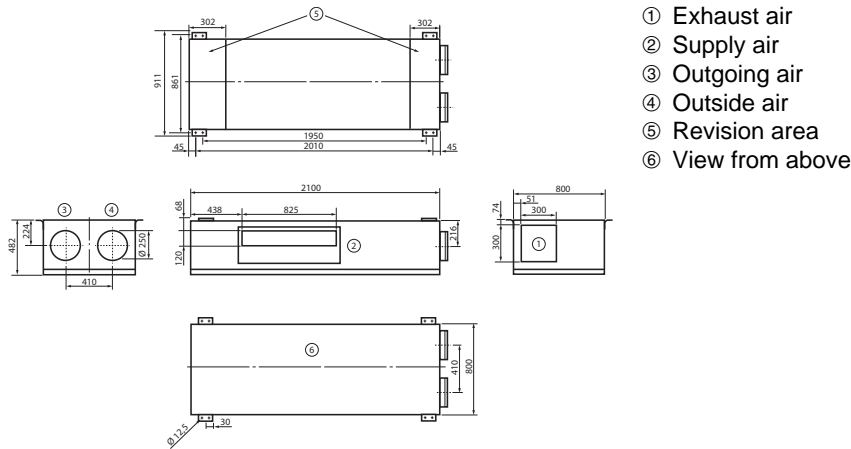

## Dimensioned drawing [mm]

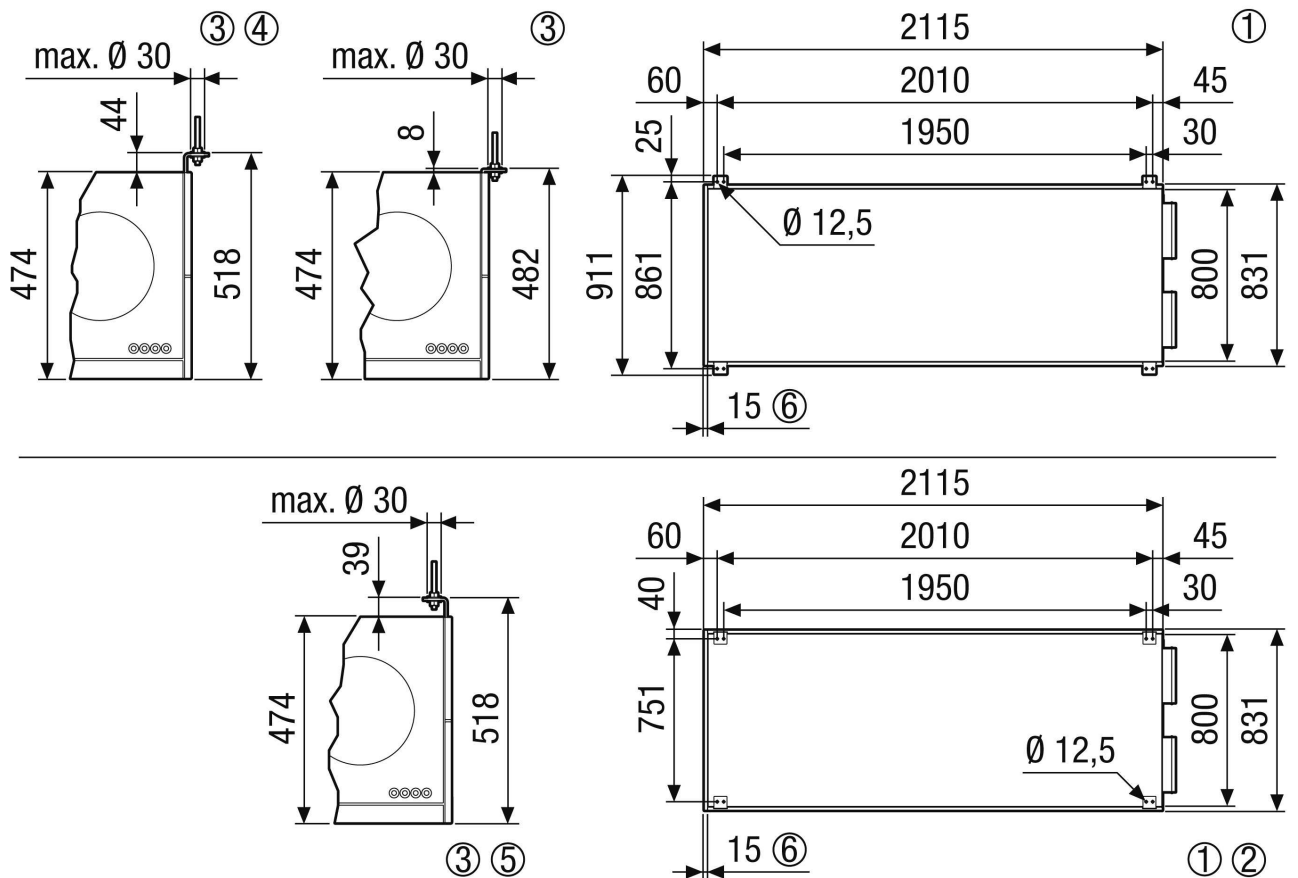

- ① Ceiling mounting geniovent.x 600-900 FR. View of the unit from the ceiling
- ② Optional with a fixing bracket rotated by 180°
- ③ Designed for ceiling mounting, e.g. with M10 threaded rods
- ④ Optional, the fixing bracket can be moved up by 36 mm.



# geniovent.x 600 F R-G-SO-K

⑤ Optional, the fixing bracket can be moved up by 36 mm and rotated by 180°.