

## DZS 50/6 B Ex e

### Wall-mounted fans for air extraction

- Air extraction can prevent the formation of a potentially explosive atmosphere from combustible fluids.
- To achieve this, the air/gas mix is extracted from the point at which it is produced using EZQ ... E Ex e or DZQ ... Ex e wall-mounted fans.



- ① MLA or MLZ external grille
- ② Explosive atmosphere
- ③ Fan EZQ ... E Ex e or DZQ ... Ex e

### Cross-ventilation in battery rooms

As the cells are charged, hydrogen is produced in the battery rooms and collects under the ceiling. With lead batteries, sulphuric acid mist forms close to the ground at the same time. Both must be extracted.

Equip the air extraction system with exhaust air openings at floor and ceiling height for this purpose. Or extract the exhaust air directly with EZQ ... E Ex e or DZQ ... Ex e wall-mounted fans.

Supply air is fed in at the opposite end of the battery room using a separate ventilation system. If possible, the simplest solution is to use EZQ ... E Ex e or DZQ ... Ex e wall-mounted fans to blow in outside air.

- ①
- ② EZQ 20 E Ex e / DZQ ... EX e supply air fan
- ③ Batteries on charge
- ④ Potentially explosive atmosphere (hydrogen)
- ⑤ Sulphuric acid mist
- ⑥ Exhaust fan EZQ 20 E Ex e / DZQ ... Ex e for extracting hydrogen
- ⑦ Exhaust fan EZQ 20 E Ex e / DZQ ... Ex e for extracting sulphuric acid mist

### Wall installation with extension sleeve

- Insert the conical wall mounting ring of the fan into the VH extension sleeve using light pressure.
- Insert the fan into the wall together with the extension sleeve.
- Fill the gap between the extension sleeve and the external wall with plaster or add another extension sleeve of a suitable length.

# INSTALLATION INSTRUCTIONS

## DZS 50/6 B Ex e

- Please note: Do not install the extension sleeve on the fan side flush with the plaster, as then the fan cannot be mounted on the wall.

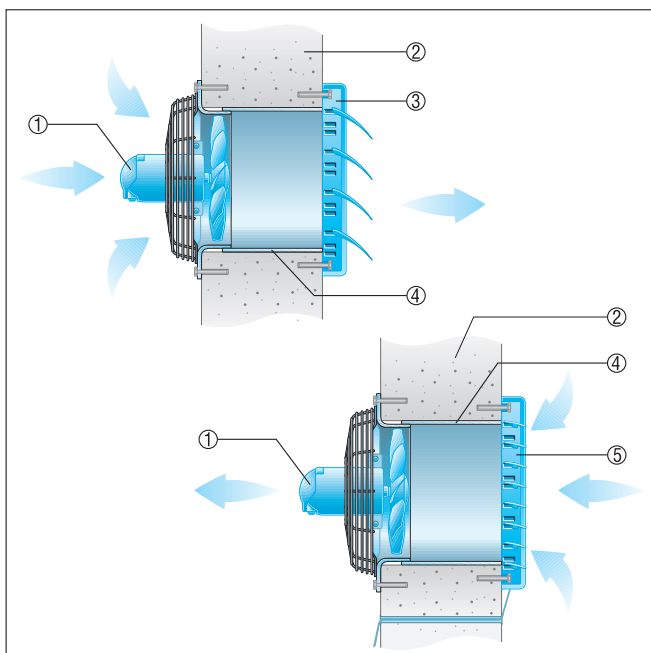

- ① Fans
- ② External wall
- ③ AS shutter, airstream-operated
- ④ VH extension sleeve
- ⑤ RS shutter, electrically or manually operated

### Installation in thin walls

- Spacing frame, see Recommended Accessories: The fan is fastened using the supplied fixing brackets.

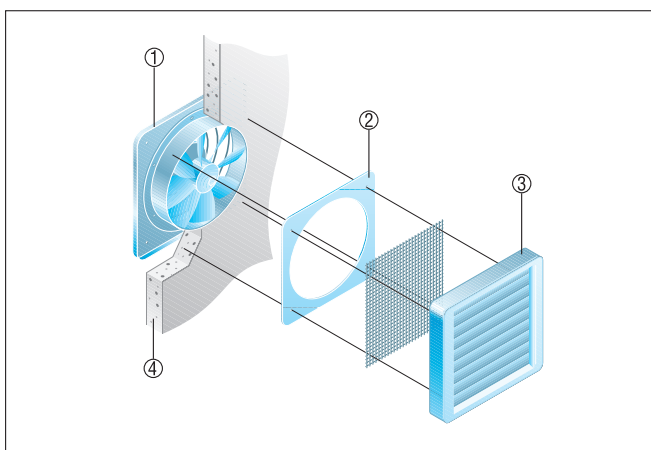

- ① Fans
- ② Spacing frames
- ③ AS shutter, airstream-operated
- ④ External wall