

INSTALLATION INSTRUCTIONS

ERM 25 Ex t/60 Hz

Installation in ventilation ducts

- The illustration shows the installation of an ERM-Ex fan within a duct system.
- Use FUM foot to fix the fan to the wall or ceiling. The mounting foot can be fixed to the fan circumference, in any position, using the tapping screws provided.

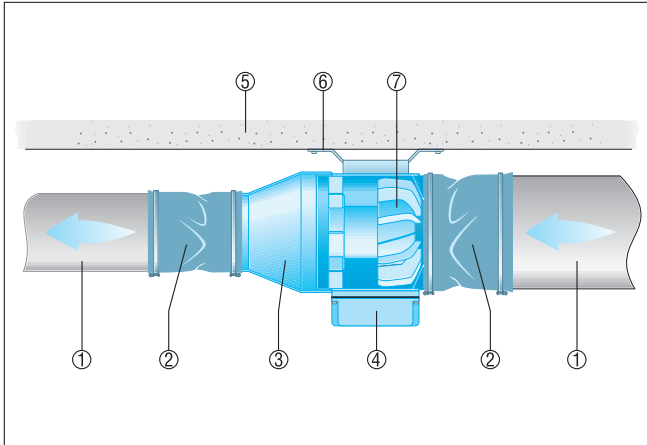

- ① Ventilation duct, to be provided by the customer
- ② ELM-Ex flexible cuffs
- ③ REM-Ex reducer
- ④ Terminal box
- ⑤ Ceiling, girder
- ⑥ FUM mounting foot
- ⑦ ERM-Ex fan

Installation at the end of the line, free fan inlet

- The illustration shows the installation of an ERM-Ex fan at the end of a duct system.
- Use FUM foot to fix the fan to the wall or ceiling. The mounting foot can be fixed to the fan circumference, in any position, using the tapping screws provided.
- In case of free air outlet, use protective grille SGM-Ex.

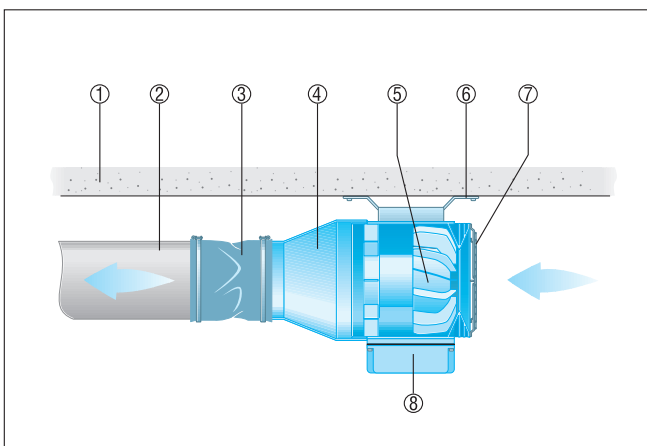

- ① Ceiling, girder
- ② Ventilation duct, to be provided by the customer
- ③ ELM-Ex flexible cuffs
- ④ REM-Ex reducer
- ⑤ ERM-Ex fan
- ⑥ FUM mounting foot
- ⑦ SGM-Ex protective grille
- ⑧ Terminal box