

WIRING DIAGRAM

RLT FLAT 700 M4007H R Mode 3



- ESA – Outside switchboard
- FV 1 – Filter 1 dirty
- FV 2 – Filter 2 dirty
- R/St/Sto – Remote control/Start/Stop
- RM – Smoke detector
- FA – Fire alarm
- BK – Bypass shutter
- ext – External
- disp – Display
- KA – Shutter drives
- SS – System status
- GA – General alarm
- AK – External shutter
- o – Optional
- ABK – Exhaust air shutter
- AT – Outside air temperature
- RT – Exhaust air temperature
- ZT – Supply air temperature
- ABT – Outgoing air temperature
- TPW – Temperature of the plate heat exchanger
- FT – Flow Measuring Transducer
- T – Sensor
- P1 – Connection 1
- P2 – Connection 2

WIRING DIAGRAM

RLT FLAT 700 M4007H R Mode 3

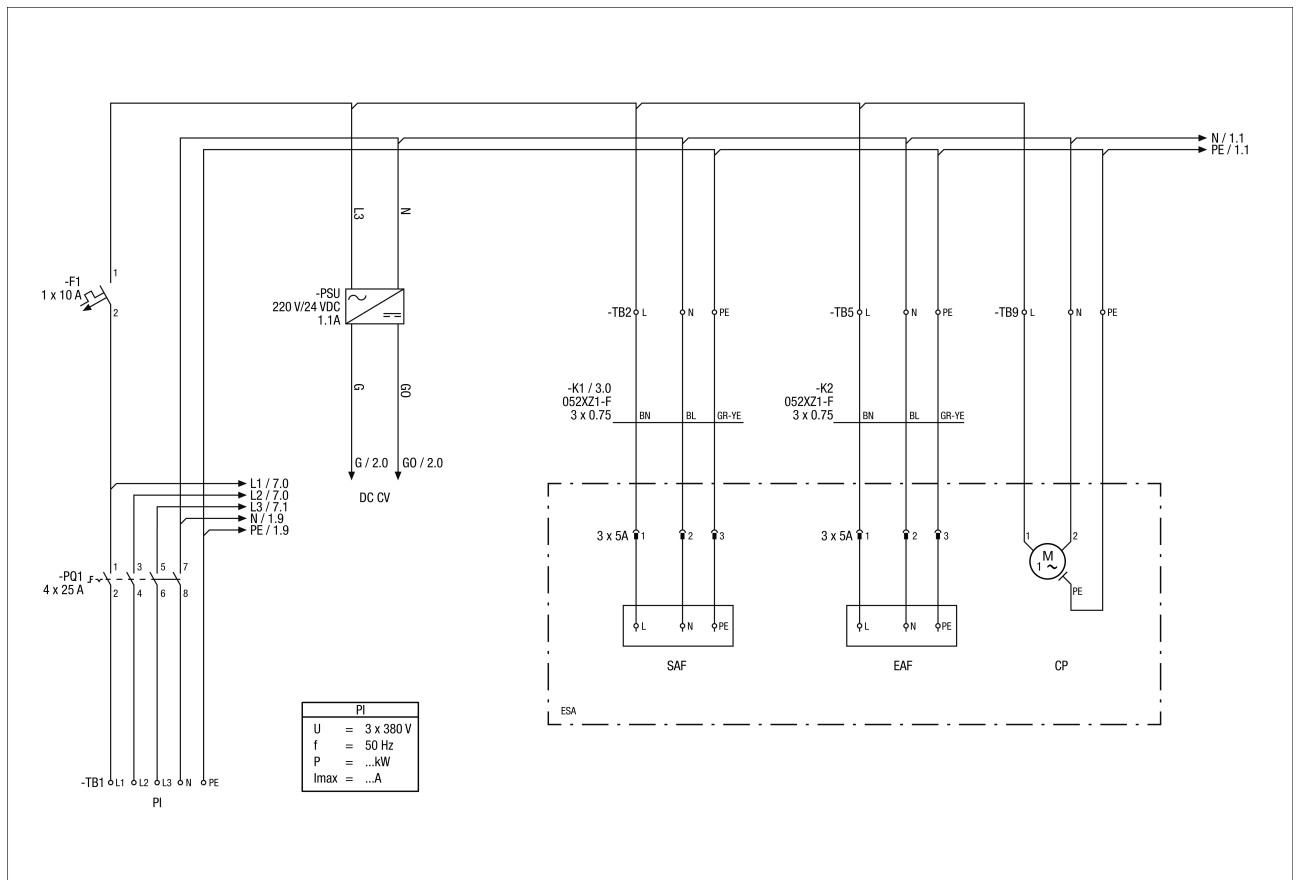

Main power connection

- PI - Power supply
- DC - CV control voltage
- SAF - Supply air fan
- EAF - Exhaust air fan
- CP - Condensate pump

WIRING DIAGRAM

RLT FLAT 700 M4007H R Mode 3

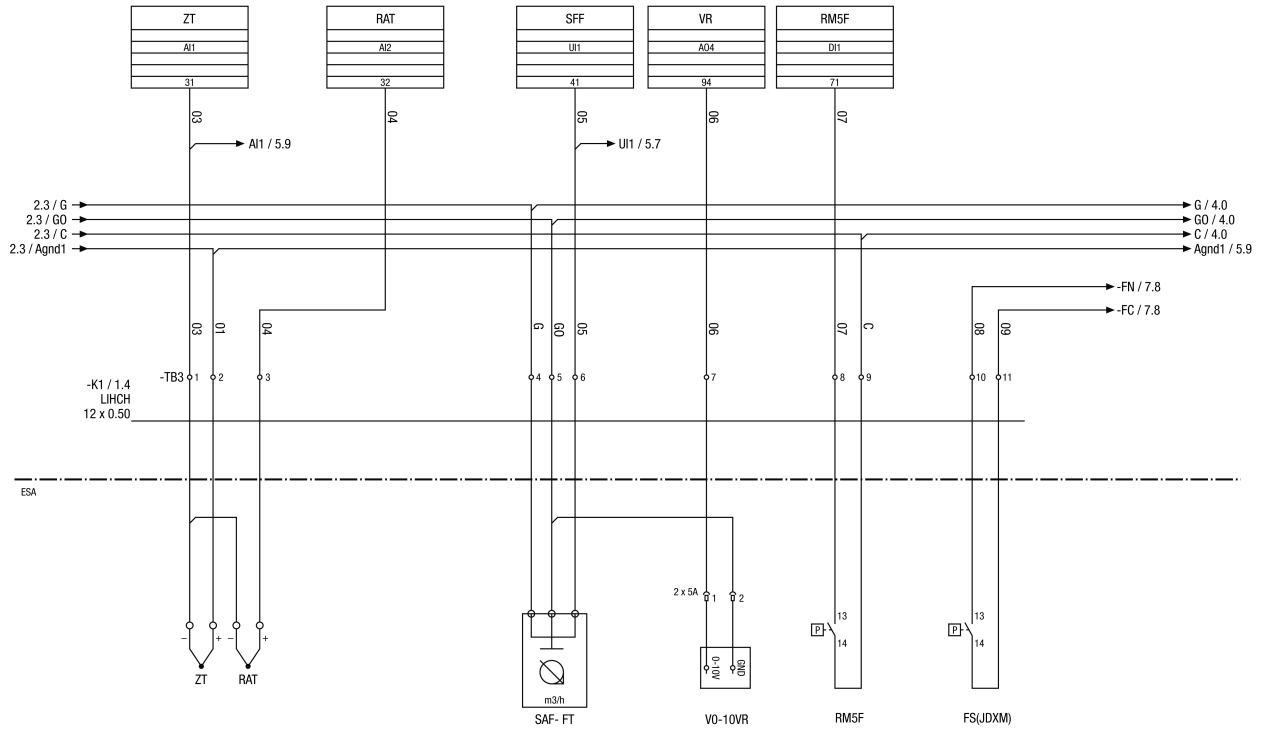

Sensor circuit diagram – main unit

- ZT - AI1 - Supply air temperature
- RAT - AI2 - Exhaust air temperature
- SFF - UI1 - Supply air fan volumetric flow
- VR 0-10V R - AO4 - Fan 0-10V reference
- RM5F - DI1 - Exhaust air filter M5
- FS (JDXM) - Fan status

WIRING DIAGRAM



RLT FLAT 700 M4007H R Mode 3

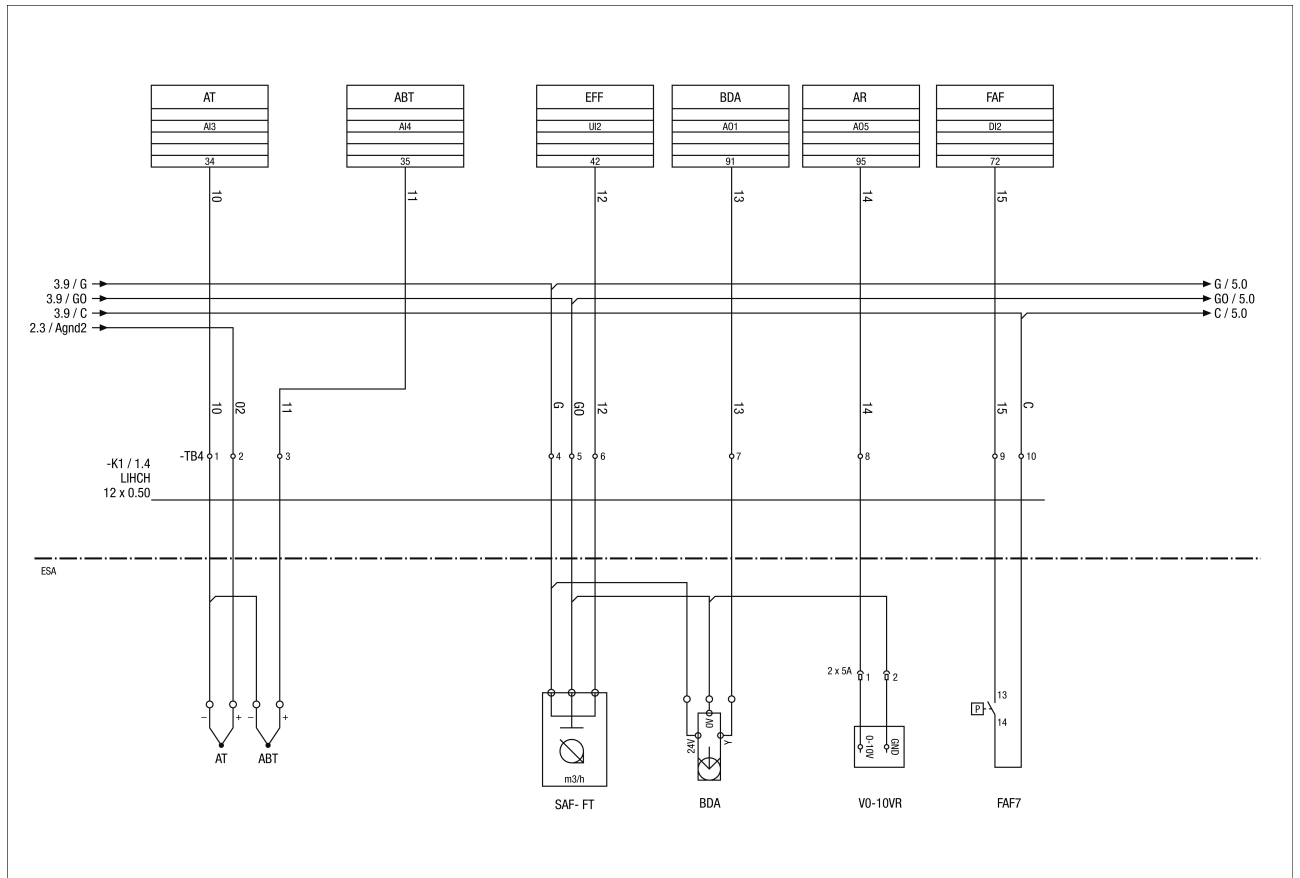

RLT FLAT sensor circuit diagram – main unit

- AT - AI3 - Outside air temperature
- ABT - AI4 - Outgoing air temperature
- EFF - UI2 - Outgoing air fan air flow
- BDA - AO1 - Bypass damper actuator
- AR - AO5 - Suction side reference pressure
- FAF - DI2 - Outside air filter F7
- V010VR - Fan 0-10V reference

WIRING DIAGRAM

RLT FLAT 700 M4007H R Mode 3

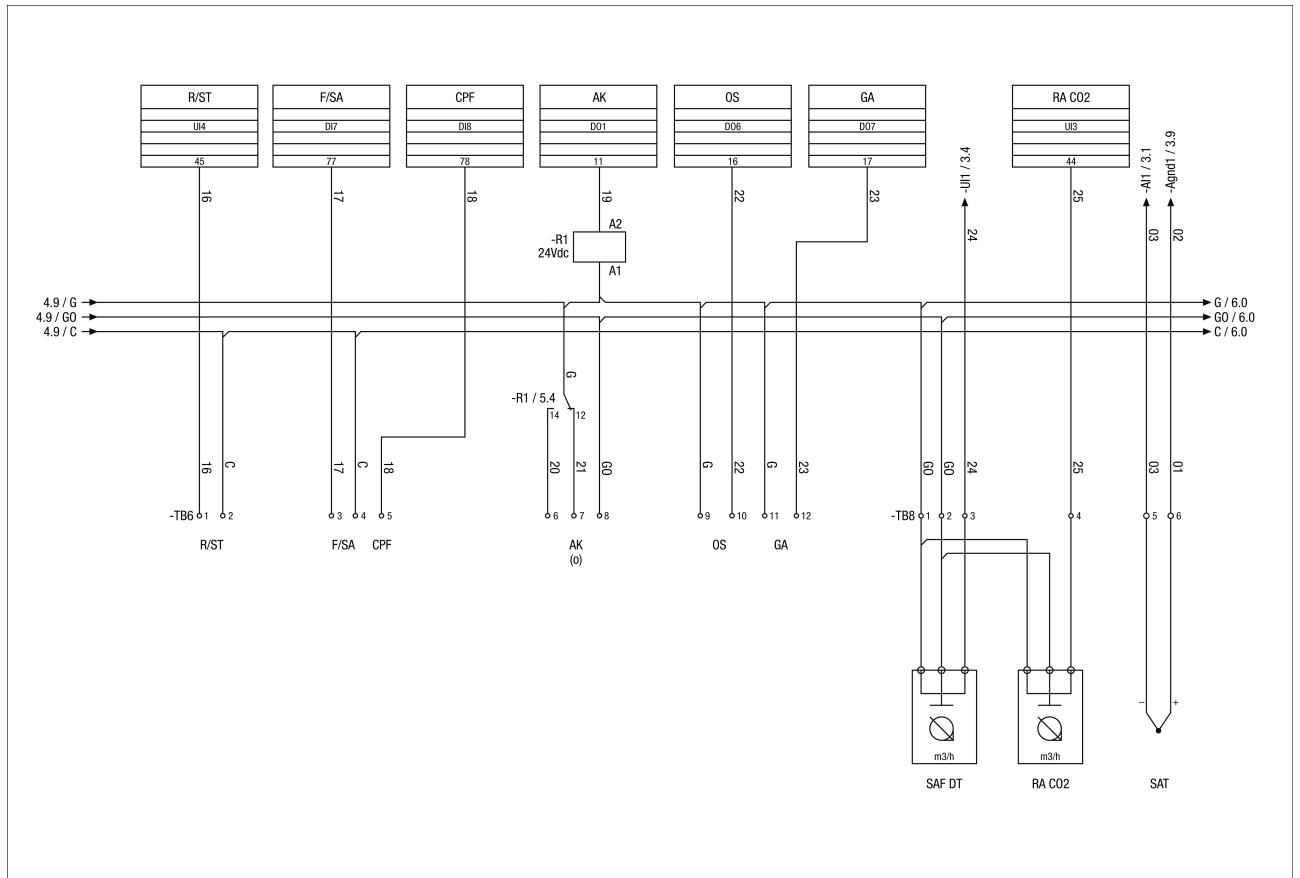

RLT FLAT sensor circuit diagram – main unit modes 3 & 5

- R/ST - UI4 Remote Start
- F/SA - DI7 Fire/smoke alarm
- CPF - DI8 Condensate pump malfunction
- AK - DO1 shut-off damper for outside air
- OS - DO6 Operating status
- GA - DO7 General alarm
- RA CO2 - UI3 Exhaust air CO2 (ppm)
- SAT DT channel transmitter (only for mode 3)
- SAT supply air temperature (for dismantling applications)

WIRING DIAGRAM

RLT FLAT 700 M4007H R Mode 3

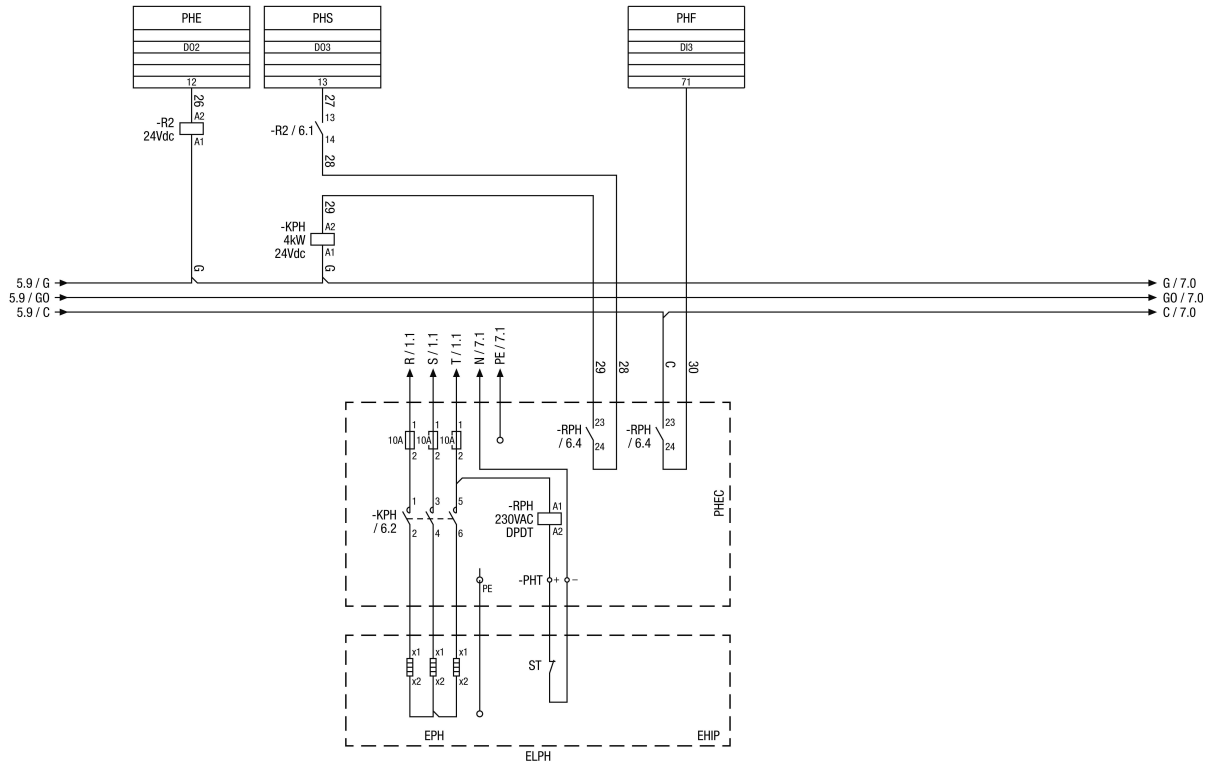

RLT FLAT circuit diagram for electric preheater

- PHE - DO2 - Activate preheater
- PHS - DO3 - Preheating register start
- PHF - DI3 - Preheater fault
- PHEC - preheating register expansion card
- ST - Safety thermostat
- EPH/ELPH – electric preheater
- EHIP – electric preheater, internal panel

WIRING DIAGRAM

RLT FLAT 700 M4007H R Mode 3

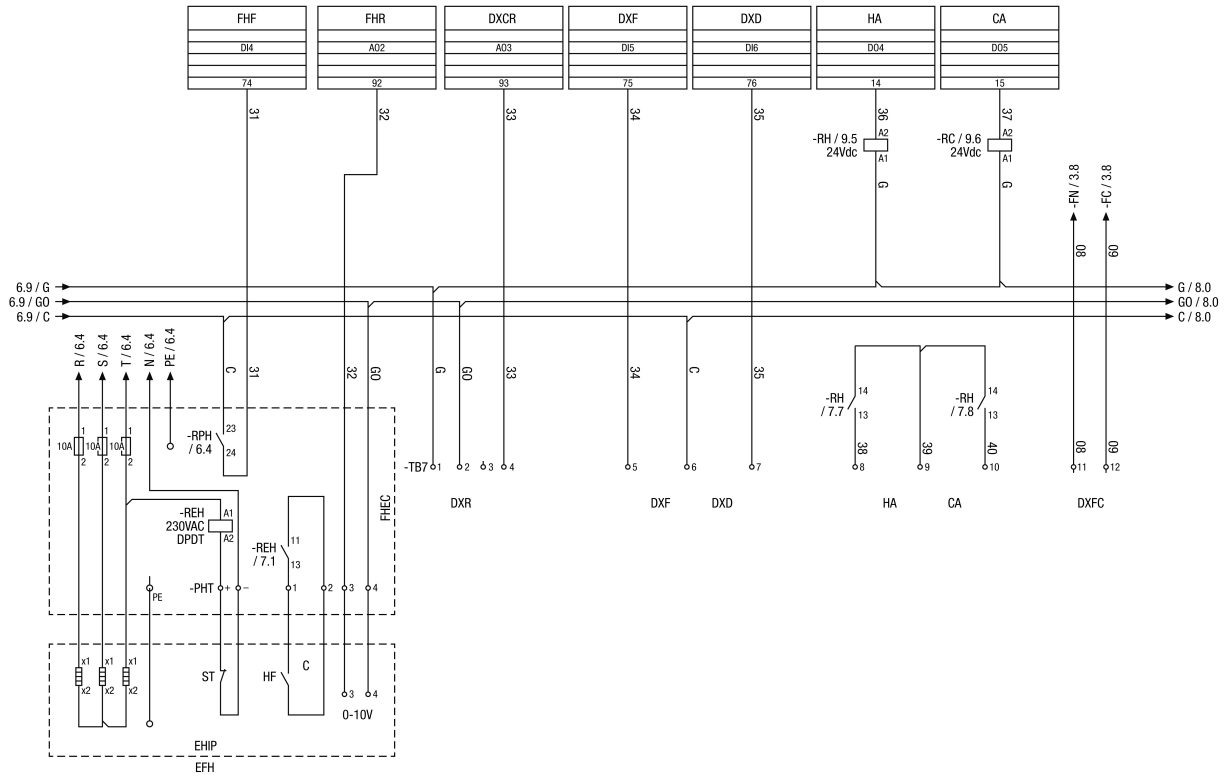

RLT FLAT circuit diagram for electric re-heater

- FHF - DI4 -Re-heater fault
- FHR - AO2 - Re-heater reference
- DXCR - AO3 - DX Cooling register reference
- DXF - DI5 - DX Fault
- DXD - DI6 - DX Defrosting
- HA - DO4 - Heating active
- CA -DO5 - Cooling active
- ST - Safety thermostat
- HF - Heating fault
- C - Contact
- EHIP – Electric heater, inner panel
- EFH – Electric re-heater
- DXR - DX Reference 0-10V (terminals 2-4)
- DXFC - DX Volumetric flow check

WIRING DIAGRAM

RLT FLAT 700 M4007H R Mode 3

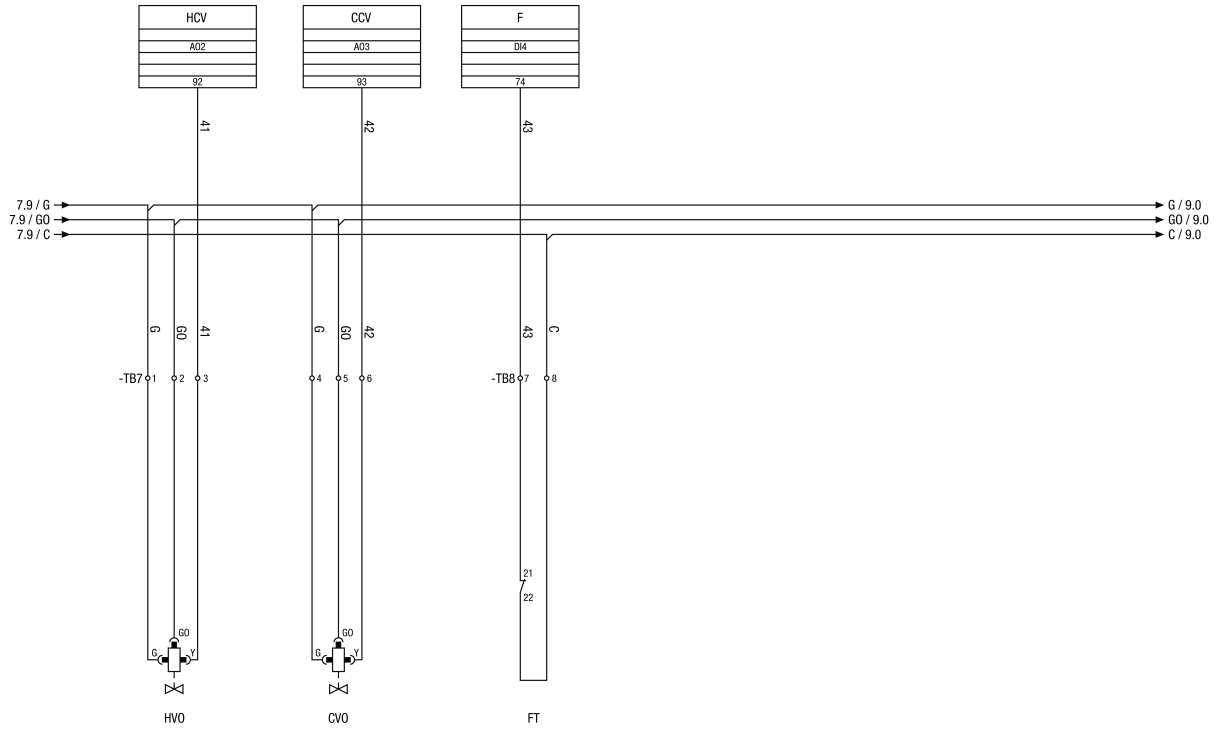

RLT Flat circuit diagram for water re-heater and cooling register

- HCV - AO2 - Valve heat register
- CCV - AO3 - Valve cooling register
- F - DI4 - Frost
- HVO - Valve heat register (optional)
- CVO - Valve cooling register (optional)
- FT - Frost thermostat

WIRING DIAGRAM

RLT FLAT 700 M4007H R Mode 3

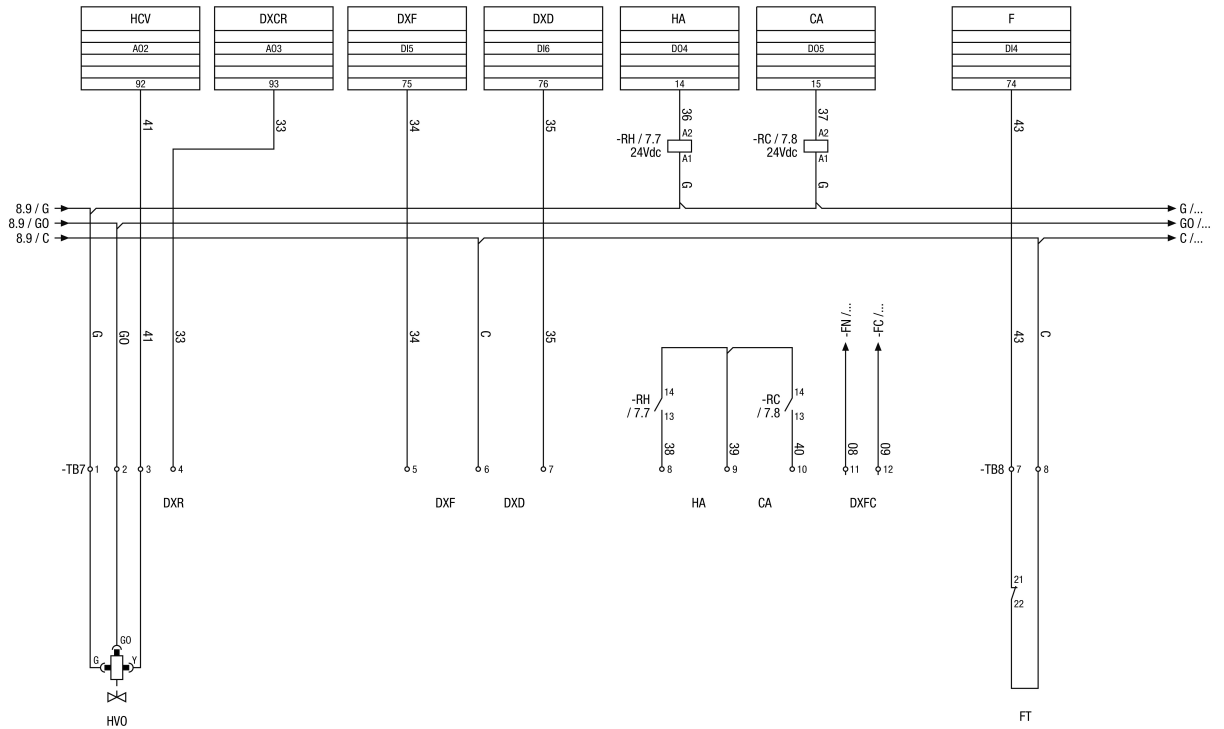

RLT FLAT circuit diagram DX register

- HCV - AO2 Valve heat register
- DXCR - AO3 DX Cooling Reference
- DXF - DI5 DX Fault
- DXD - DI6 DX Defrosting
- HA - DO4 Heating active
- CA - DO5 Cooling active
- F - DI4 Frost
- DXR - DX reference 0-10V (terminals 2-4)
- DXFC - DX Current check
- FT - Frost thermostat