

GRK R 28/2 D



Kratka informacija

Radijalno puhalo od plastike s okruglim ispuhom, ugradna veličina 280, trofazna struja, 2-polni

Primjeri primjene

Industrijska primjena

Broj artikla

0073.0516

Tehnički podaci

Volumen zraka	3.150 m ³ /h
Brzina	2.880 1/min
Tip propelera	radijalni
S mogućnošću upravljanja brzinom	✓
Mogućnost obrnutog načina rada	–
Vrsta napona	Trofazna struja
Nazivni napon	400 V
Frekvencija struje	50 Hz
Nominalna snaga	750 W
I _{Nomin.}	1,7 A
Vrsta zaštite	IP 55
Toplinska klasa	F
Moguća promjena pola	–
Mjesto ugradnje	Cijevni priključak
Položaj za ugradnju	horizontalno
Materijal kućišta	Plastika, polietilen
Materijal propelera	Plastika, polietilen
Boja	svijetlosiva
Težina	33 kg
Težina s pakovanjem	56 kg
Ugradna veličina	280
Širina	470 mm
Visina	560 mm
Dubina	515 mm
Širina s pakovanjem	1.200 mm
Visina s pakovanjem	800 mm
Dubina s pakovanjem	710 mm
Temperatura struje zraka kod I _{Maks.}	-15 °C do 70 °C
PTC DIN 44082	M 100

GRK R 28/2 D

Jedinica za pakiranje	1 kom
Asortiman	C
GTIN (EAN)	4012799735168

Razina jačine zvuka u opsegu buke

	63 Hz	125 Hz	250 Hz	500 Hz	1 kHz	2 kHz	4 kHz	8 kHz	Ukupno
L_{WA5, S5} (dB(A))	61,8	73,9	79,4	85,8	85	81,2	73	62,9	90

L_{WA5} = razina jačine zvuka slobodnog usisa u dB

Krivulja

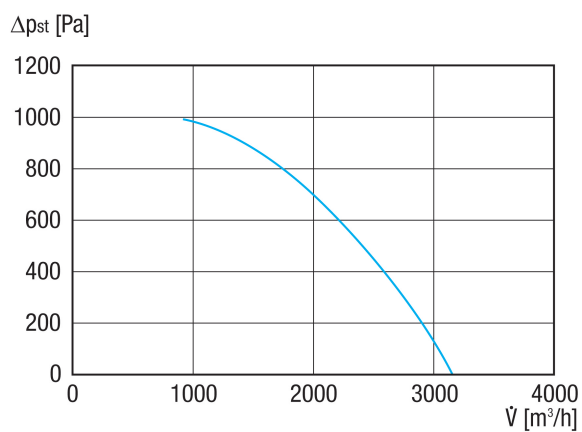

GRK R 28/2 D

Crtež s veličinama [mm]

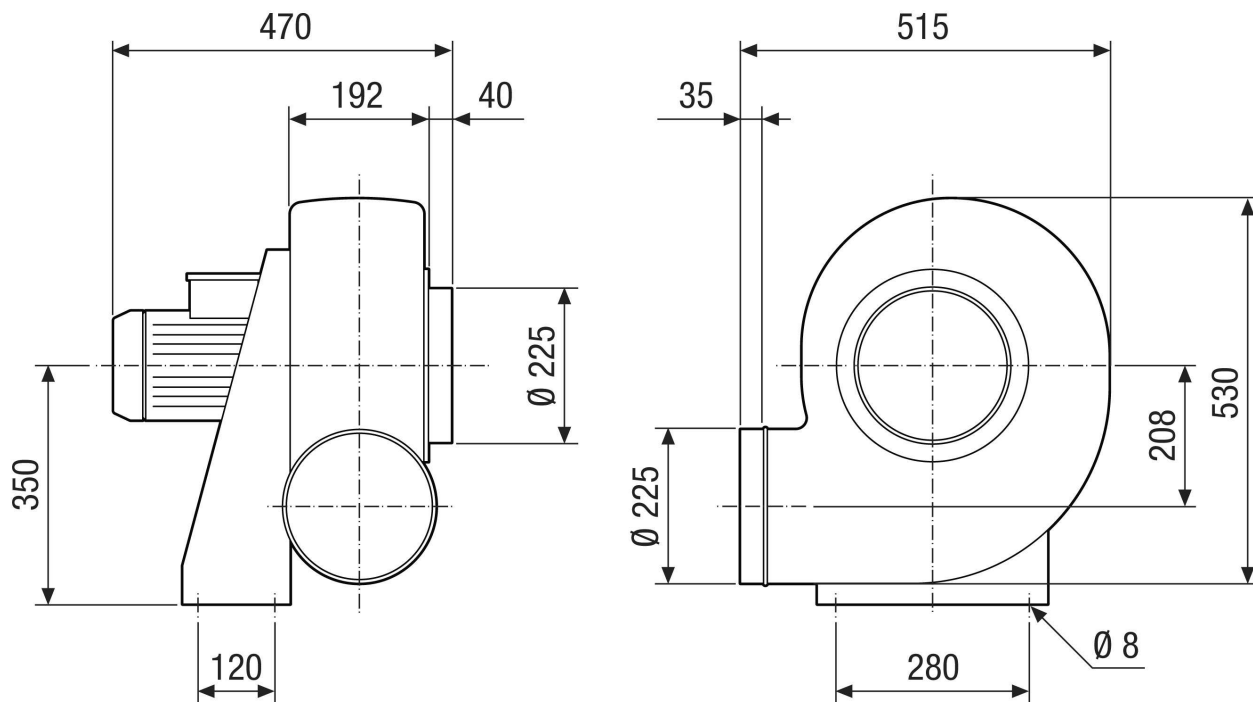

GRK R 28/2 D

Crtež s veličinama Poravnanje kućišta [mm]

①						
	0°	45°	90°	135°	270°	315°
②						

① RD model na desnoj strani

② LG model na lijevoj strani

Varijante GRK 12/2 E i GRK 12/4 D nisu dostupne u modelu na desnoj strani RD!

Standardno namještanje je uvijek LG 270°