

# EZF 30/4 B

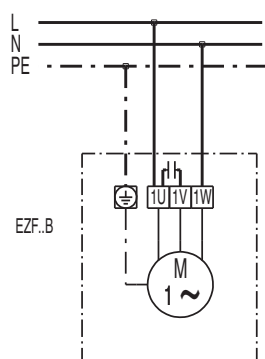

EZF 30/4 B

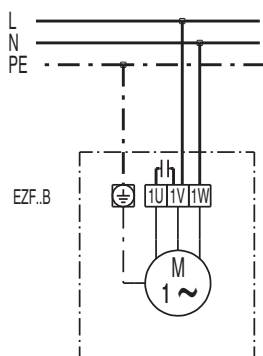
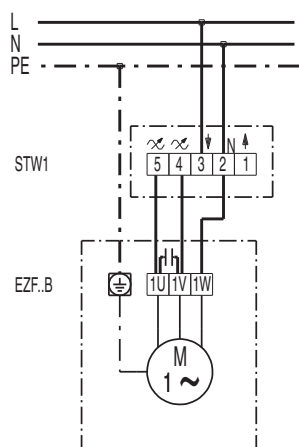
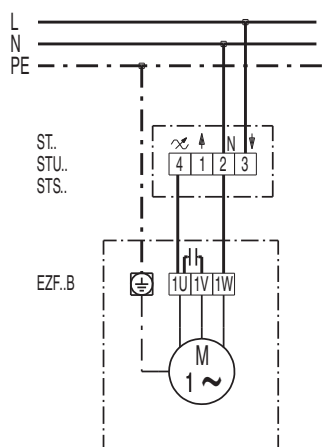

EZF 30/4 B

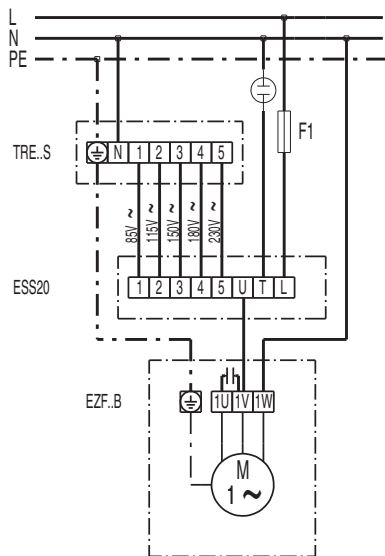
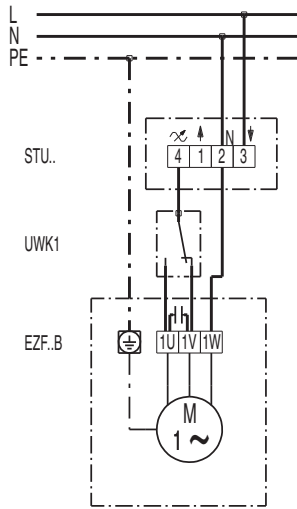

EZF 30/4 B

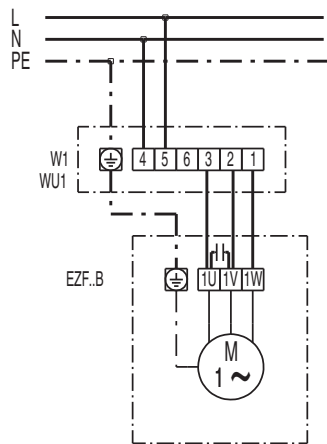
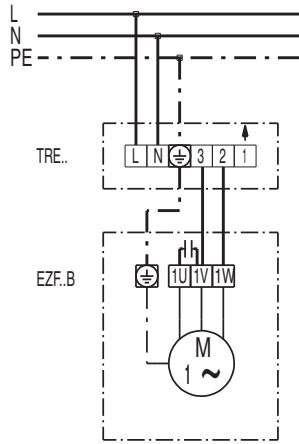

# PRIKLJUČNE SCHEME

## EZF 30/4 B

