

PRIKLJUČNE SCHEME

EZF 30/6 B

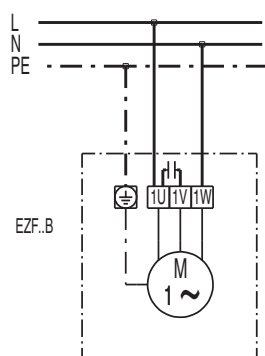

EZF 30/6 B

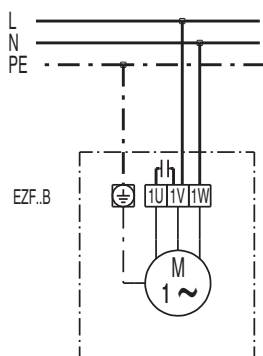
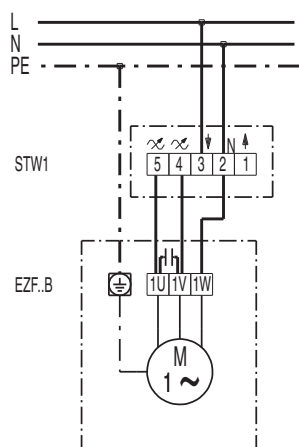
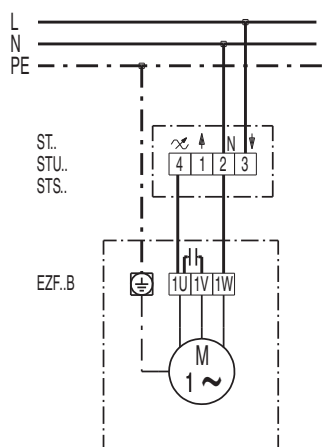

EZF 30/6 B

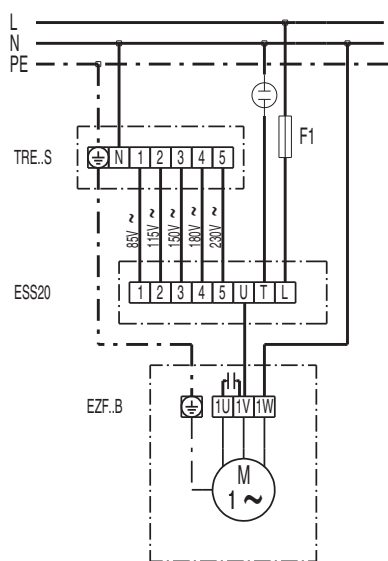
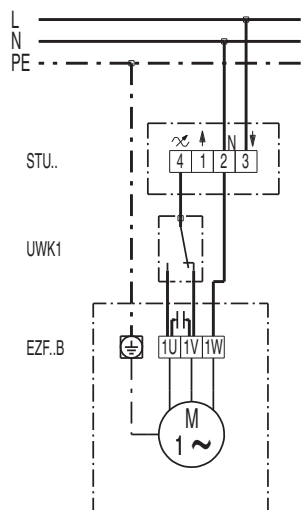

EZF 30/6 B

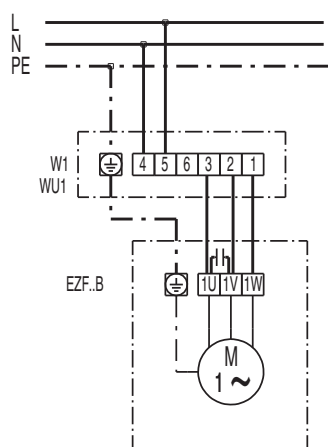
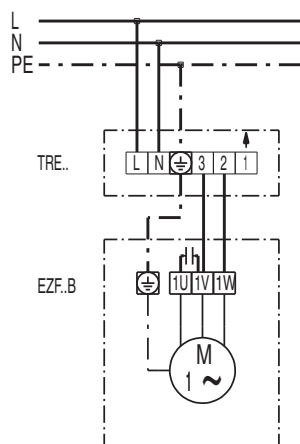

EZF 30/6 B

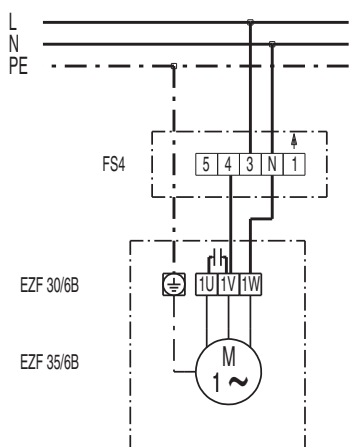
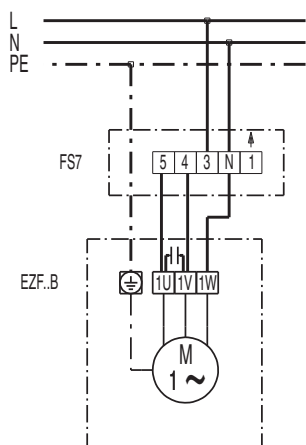

PRIKLJUČNE SCHEME

EZF 30/6 B

