

DZR 60/84 B

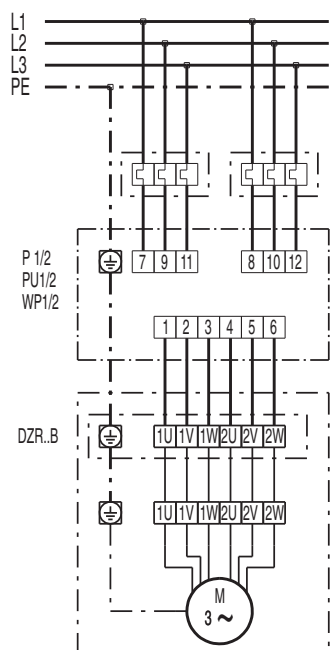

# DZR 60/84 B

