

# DZS 60/8 B

## DZQ/DZS/DZF..B standardowy (obroty w prawo, 1 prędkość obrotowa)



SC - zestyk ochronny  
TK - zestyk termiczny

## DZQ/DZS/DZF..B standardowy (obroty w lewo, 1 prędkość obrotowa)

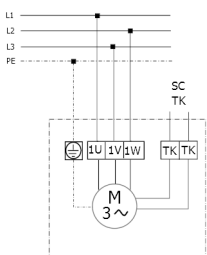

SC - zestyk ochronny  
TK - zestyk termiczny

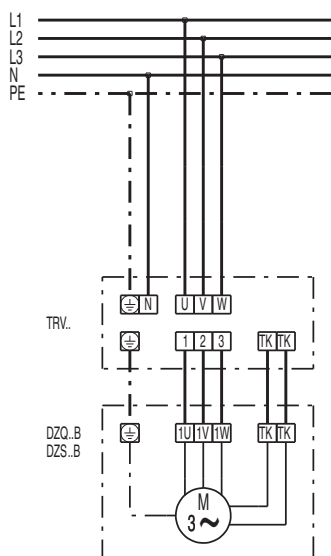

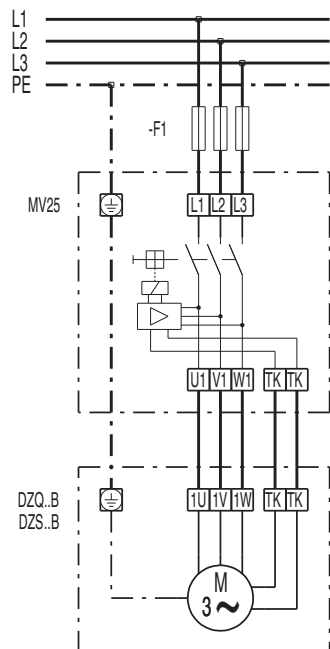

DZS 60/8 B

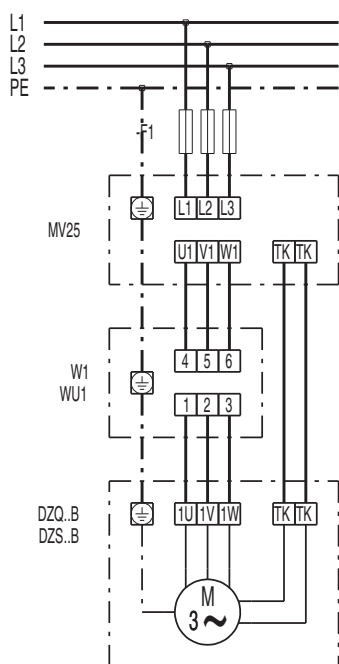

DZS 60/8 B

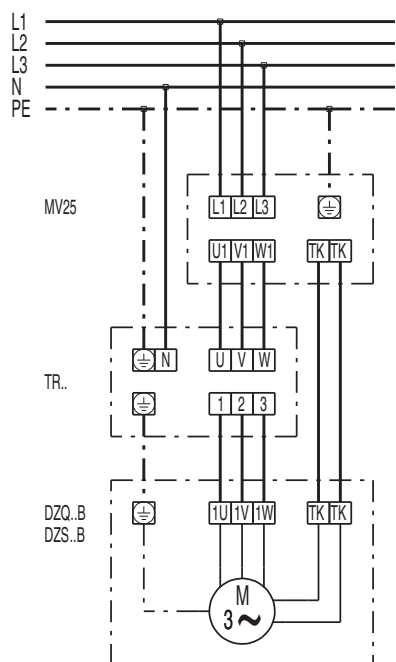

DZS 60/8 B

